

50

DENON

Hi-Fi Component

SERVICE MANUAL

STEREO CASSETTE TAPE DECK

MODEL DR-F6/F7/F8

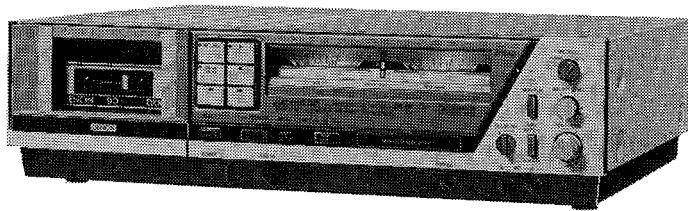

DR-F6

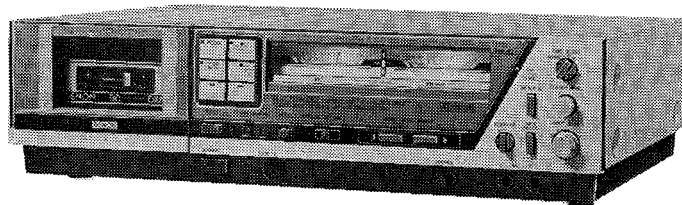

DR-F7/F8

NIPPON COLUMBIA CO., LTD.

TABLE OF CONTENTS

MAIN FEATURES	1
SPECIFICATIONS	2
PART NAMES AND FUNCTIONS	3~4
BLOCK DIAGRAM (DR-F6)	5
LEVEL DIAGRAM (DR-F6)	6
BLOCK DIAGRAM (DR-F7/F8)	7
LEVEL DIAGRAM (DR-F7/F8)	8
THE FTS	9~11
DISASSEMBLY INSTRUCTIONS	12
ADJUSTING AND CHECKING THE MECHANISM SECTION	13~15
ADJUSTING THE ELECTRICAL SECTIONS	16~19
PARTS LIST OF MECHANISM UNIT	20~21
PARTS LIST OF EXPLODED VIEW	21~22
PARTS LIST OF P.C. BOARD	23~27
EXPLODED VIEW OF MECHANISM UNIT	28
EXPLODED VIEW OF CABINET AND CHASSIS GROUP	29~30
CONNECTIONS OF P.C. BOARD	31~32
SCHEMATIC DIAGRAM OF LOGIC AND POWER UNIT	33~34
SCHEMATIC DIAGRAM OF AUDIO AMP	35~36
SCHEMATIC DIAGRAM OF DOLBY AMP	37
P.C. BOARD OF KU-0435 AUDIO AMP. UNIT	38
P.C. BOARD OF KU-0422 AUDIO AMP. UNIT	39~40
P.C. BOARD OF KU-0423 DOLBY AMP. UNIT	41~42
P.C. BOARD OF KU-0421 LOGIC AND POWER UNIT	43~44
P.C. BOARD OF KU-0426 P.L.S. DD UNIT, AND KU-0439 LEADER DETECTOR UNIT, KU-0434 QUARTS LOCKED UNIT AND KU-0446/0447 POWER WIRING UNIT	45

MAIN FEATURES

- Three head system with recording/playback combination head, capable of metal tape applications.
- FTS tuning system with microprocessor (DR-F7/F8).
- Flat Twin DD motor with IC logic feather touch controls.
- Quartz Lock Flat Twin DD motor (DR-F8).
- Newly developed tape tension servo sensor.
- DC audio amplifier.
- New non-slip reel drive mechanism.
- Dolby type B and type C.
- Double Dolby systems and separate MPX filter switch.
- DENON original PAUSE/MUTE button.
- Three-color, three-point peak level indicator.
- Timer recordings and timer playback facilities.
- Front panel remote control jack.

SPECIFICATIONS

Type	Vertical tape loading 4-track 2-channel stereo cassette tape deck
Heads	Recording/Playback combination head (hard permalloy) x 1 Erase head (Ferrite) x 1
Motors	Flat-Twin direct drive motor (for capstan) x 1 (DR-F6/F7) Quartz lock Flat-Twin direct drive motor x 1 (DR-F8) DC motor (for reel winding) x 1
Tape speed	4.8 cm/sec.
Fast forward, rewind time	Approx. 90 sec. with a C-60 cassette tape
Recording Bias	Approx. 105 KHz
Overall S/N ratio (at 3% THD level)	Dolby B ON more than 67 dB (CCIR/ARM) Dolby C ON more than 73 dB (CCIR/ARM)
Overall frequency response	25-21,000 Hz \pm 3 dB (at -20 dB METAL tape) 30-20,000 Hz \pm 3 dB (at -20 dB CrO ₂ tape) 30-19,000 Hz \pm 3 dB (at -20 dB LH tape)
Frequency range	20-22,000 Hz (at -20 dB METAL tape) 20-21,000 Hz (at -20 dB CrO ₂ tape) 20-20,000 Hz (at -20 dB LH tape)
Channel separation	More than 40 dB (at 1KHz)
Crosstalk	More than 65 dB (at 1 KHz)
Wow & flutter	Less than 0.025% w.rms (DR-F8) Less than 0.027% w.rms (DR-F6/F7)
Input	
microphone	0.35 mV (-67 dB) with input level control at maximum. Input impedance: 10 Kohm unbalanced.
line	70 mV (-21 dB) with input level control at maximum. Input impedance: 47 Kohm unbalanced.
Output	
line	775 mV (0 dB) with output level control at maximum. (with 10 Kohm load, recorded level of 200 Pwb/mm)
headphone	1.2 mW with output level control at maximum (optimum load impedance 8 ohm - 2 Kohm).
Accessories	Parallel pin cord with gold plated terminals x 2, cleaning stick set x 1 (DR-F8) Parallel pin cord x 2, cleaning stick set x 1 (DR-F6/F7)
Power supply	50 Hz/60 Hz compatible Note: The rated supply voltage is preset to match that used in the country of original shipment.
Power consumption	36 W
Dimensions	434W x 117H x 320D (mm)
Weight	7.5 Kg

- Above specifications and design styling are subject to change without notice for improvement.
- "Dolby" and the symbol  are the registered trademarks of Dolby Laboratories Licensing Corporation. The Dolby Noise reduction system is licensed by Dolby Laboratories Licensing Corporation.

PART NAMES AND FUNCTIONS

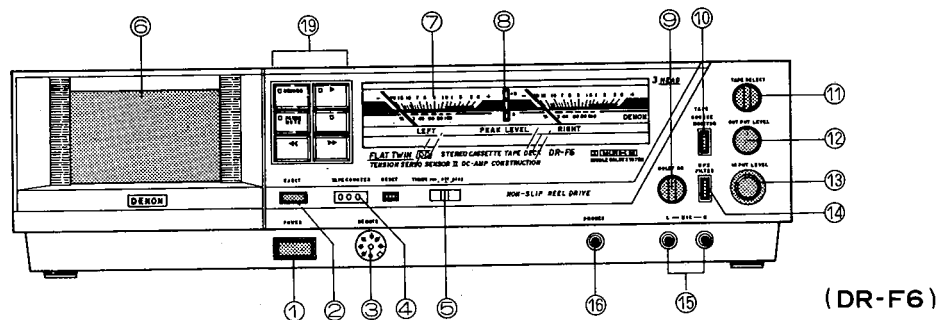

(DR-F6)

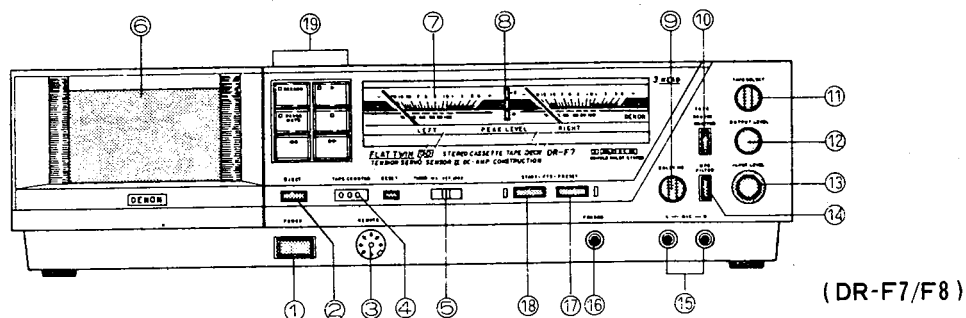

(DR-F7/F8)

1. Power switch (POWER)

Make sure the timer switch is at the "off" position and then push the power switch to turn "on" (▲) the power. The lamps in the level meters and the tape window will light up. The set is now ready for operation. Push the switch again to turn "off" (■) the power.

2. Eject button (EJECT)

This button opens the cassette compartment to permit the insertion and removal of the cassette tape.

3. Remote control jack (REMOTE)

The remote controller (Model RC-57), separately available, can be connected for remote control of the deck. Even when the RC-57 is connected to the jack, the control buttons on the deck continue to function.

4. Tape counter (TAPE COUNTER)

The number in the counter indicates the amount of tape wound up. It is a great convenience if you write down the counter indication as well as the recorded content for instant reference. Press the reset button to reset the counter to "000".

5. Timer switch (TIMER)

When starting recordings with the timer, set the timer switch to the "rec" position; for starting playback with the timer, set to the "play" position. Set the timer switch to the "off" position except when recording or playing back using the timer.

6. Cassette compartment

This holds the cassette tape and sets it to its operational position. While the cassette compartment is open, the control buttons do not function.

7. Level meter (LEVEL METER)

The input/output levels are indicated. When the monitor switch is set to SOURCE, the input signal level is indicated. When the switch is set to TAPE, the playback output level is indicated.

8. Peak level indicator (PEAK)

9. Dolby NR switch (DOLBY NR)

The Dolby system functions properly when the conditions for recording and playback are the same. When playing back Dolby encoded tapes, set the Dolby switch to the same position as in recording. (Type C recording — type C playback.)

10. Monitor switch (MONITOR)

The three head system of this tape deck provides simultaneous monitoring during recording.

TAPE (■): The recorded sound on the tape can be monitored during recording. (The green lamp will light up). Be sure to turn it to the TAPE position for playback. If set to the SOURCE position for playback, input signals through the input jacks or the microphone jacks are monitored, but not the playback signals.

SOURCE (▲): The signals through the input jacks or the microphone jacks are monitored. (The orange lamp will light up.)

11. Tape selector (TAPE SELECT)

The recording bias and equalizer are simultaneously switched for optimum setting for different kinds of tapes, including high performance metal tapes. Select the position according to the type of tape to be used.

12. Output level (OUTPUT LEVEL)

The playback output level or the record monitoring output level are adjusted independently from the level meter indications. The headphone output level is also adjusted by this knob.

13. Input level (INPUT LEVEL)

The input levels of the left and right channels are adjusted independently in accordance with the signal level to be recorded. The front knob is for the left (L) channel and the rear knob is for the right (R) channel.

14. MPX filter switch (MPX FILTER)

15. Microphone jacks (MIC)

Plug in the microphone plugs for microphone recordings. Use microphones with an output level higher than -67dB and a 6 mm diameter plug.

16. Headphone jack (PHONES)

Use for enjoying music through the headphones or for monitoring the recording. Use a headphone set with an impedance of 8 ohms to 2 Kohms.

17. FTS preset button (FTS PRESET)

This button allows the switchover between the preset standard bias/recording sensitivity and those calculated by the FTS using a microprocessor.

18. FTS start button (FTS START)

This button starts the operation of the microprocessor controlled FTS system. While the bias and the sensitivity are being automatically adjusted by the FTS, the green lamp on the left will flash. Once the adjustments are completed, the lamp will stay lit.

19. Tape control buttons

PAUSE/MUTE Button

When this button is pressed during playback, the tape transport will stop and the green lamp in the PLAY button will be turned off. An orange lamp in the PAUSE/MUTE button will light up, indicating the PAUSE condition. While this button is pressed during recording, the tape will run with no signals being recorded. When the button is released, the tape transport will stop. The orange lamp and red lamp in the REC button will light up, indicating the standby condition. When starting the recording again, press the PLAY button (▶).

RECORD Button

Load the cassette tape and press this button. This places the unit in standby for recording (pause). The red and orange lamps will light up. Press the PLAY button (▶) to start recording.

*If the erase prevention tab of the loaded cassette tape is broken off, this button does not function.

PLAY Button ▶

When pressed during STOP, FAST FORWARD or REWIND mode, playback begins and the green lamp will light up. When pressed during standby in the recording (pause) mode, the recording will start.

STOP Button ■

When pressed during any operational mode, the operation is stopped.

REWIND Button ◀◀

When pressed, the tape is rewound onto the left spool rapidly.

FAST FORWARD Button ▶▶

When pressed, the tape is wound onto the right spool rapidly.

BLOCK DIAGRAM

(DR-F6)

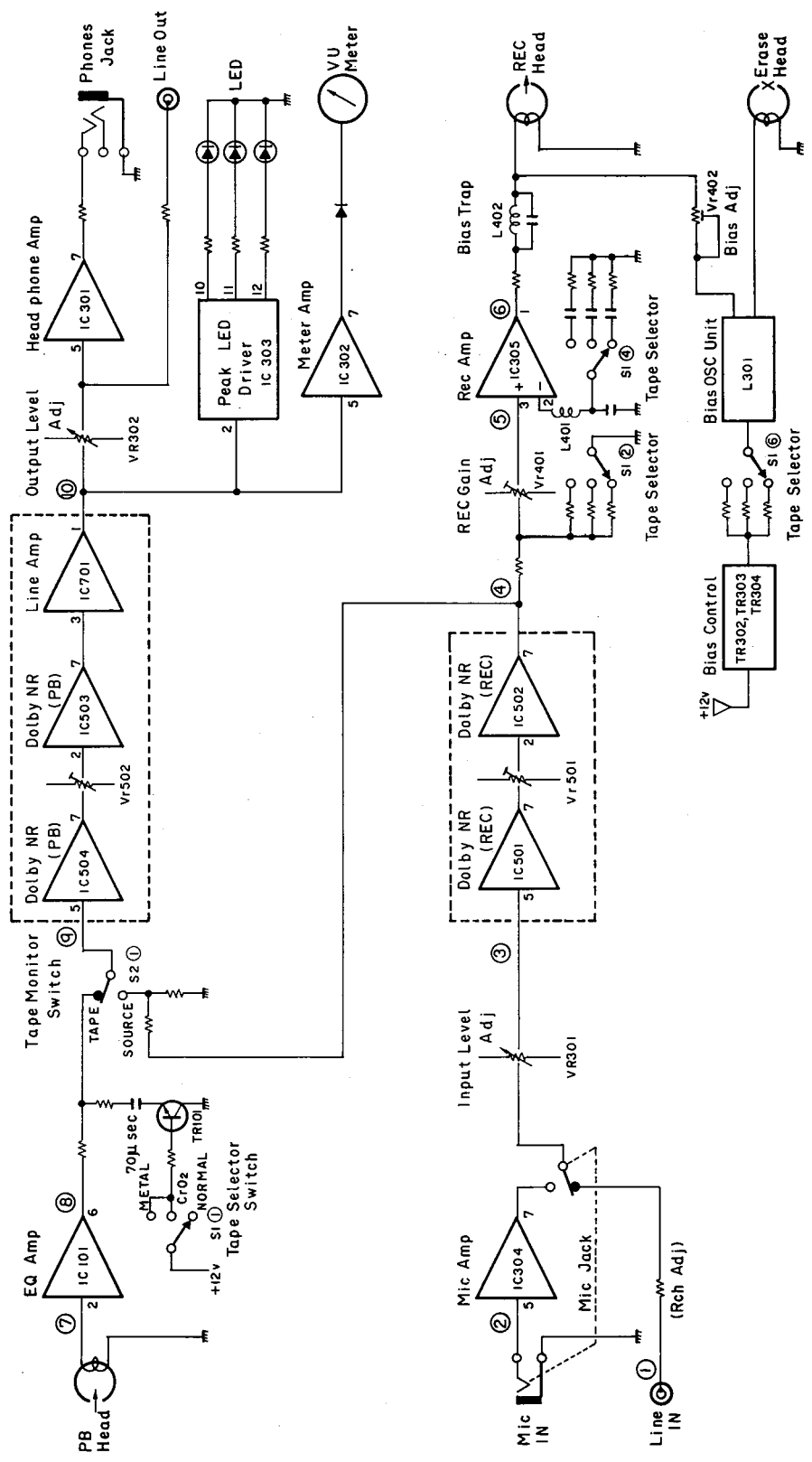

LEVEL DIAGRAM

(DR-F6)

PLAYBACK SYSTEM

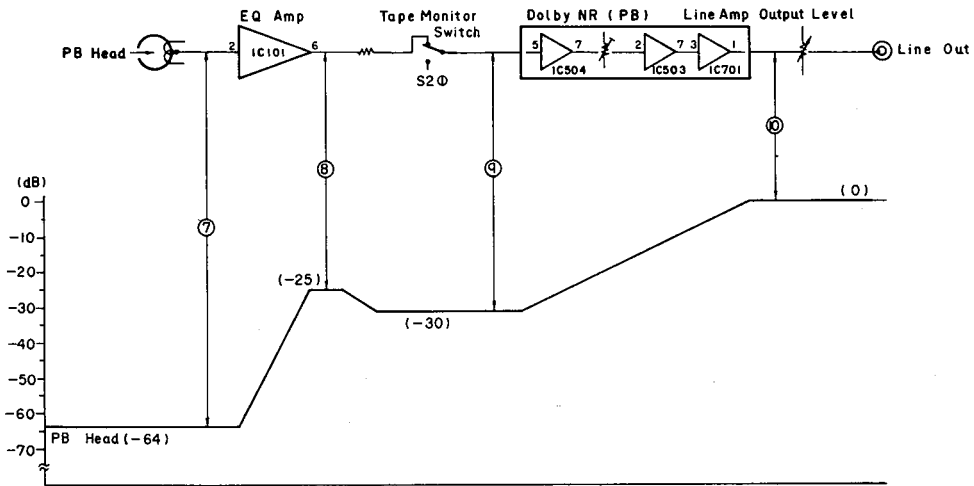

RECORDING SYSTEM

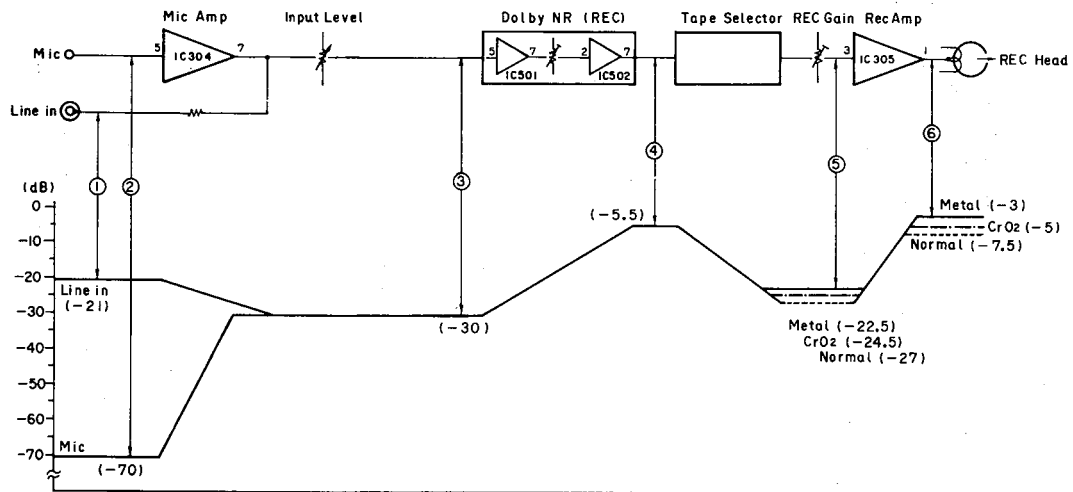

BLOCK DIAGRAM

(DR-F7/F8)

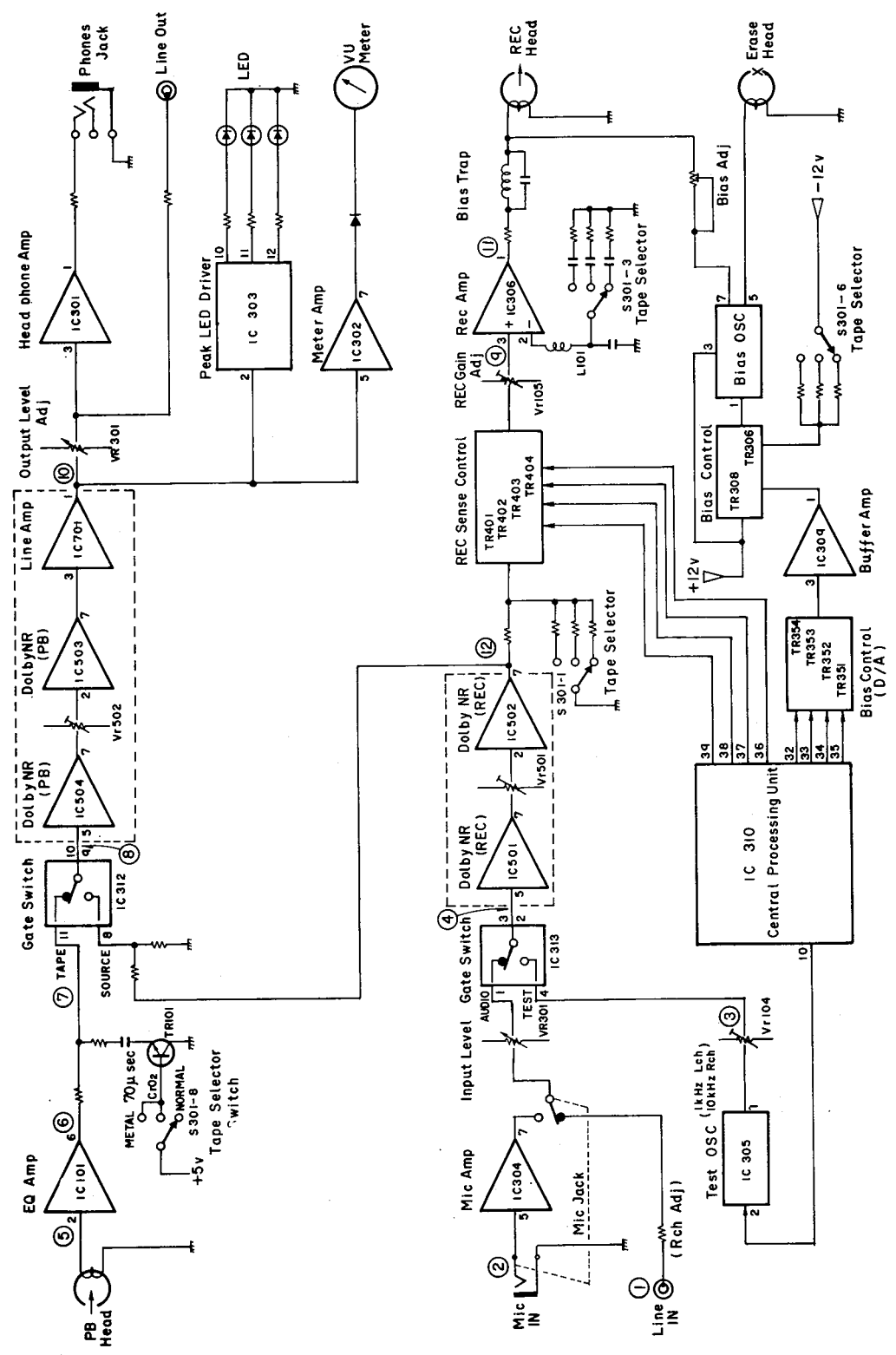

LEVEL DIAGRAM

(DR-F7/F8)

PLAYBACK SYSTEM

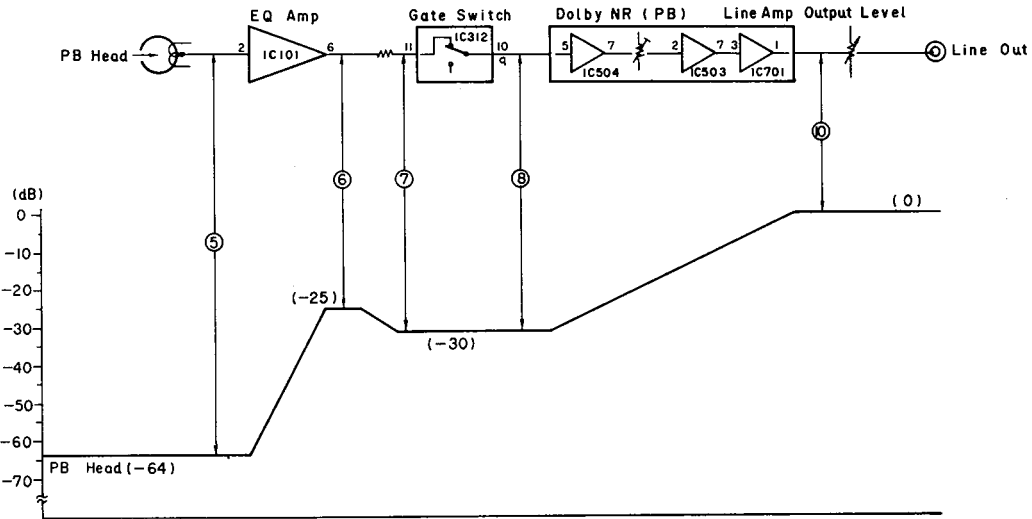

RECORDING SYSTEM

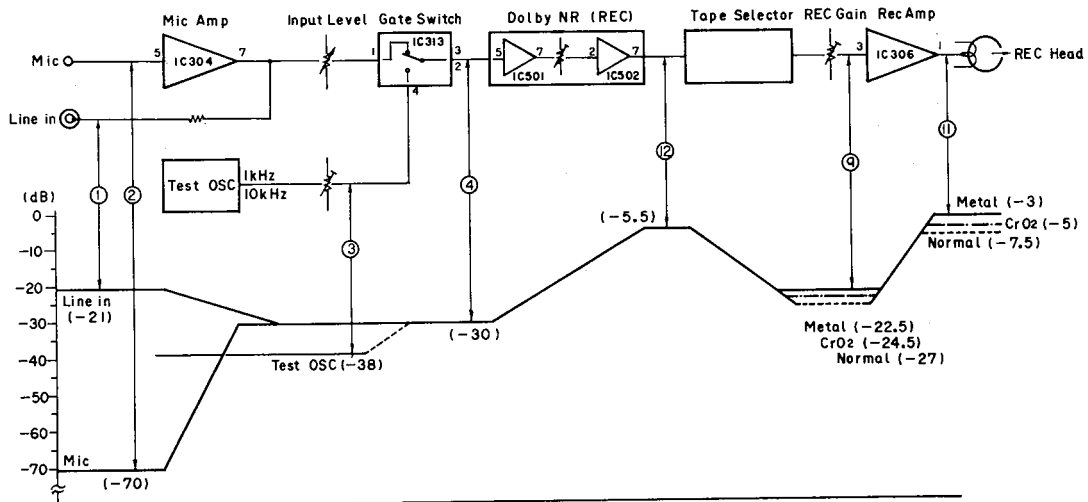

THE FTS

The FTS (Flat Tuning System) automatically adjusts the recording sensitivity and the bias, resulting in recordings with a flat frequency response.

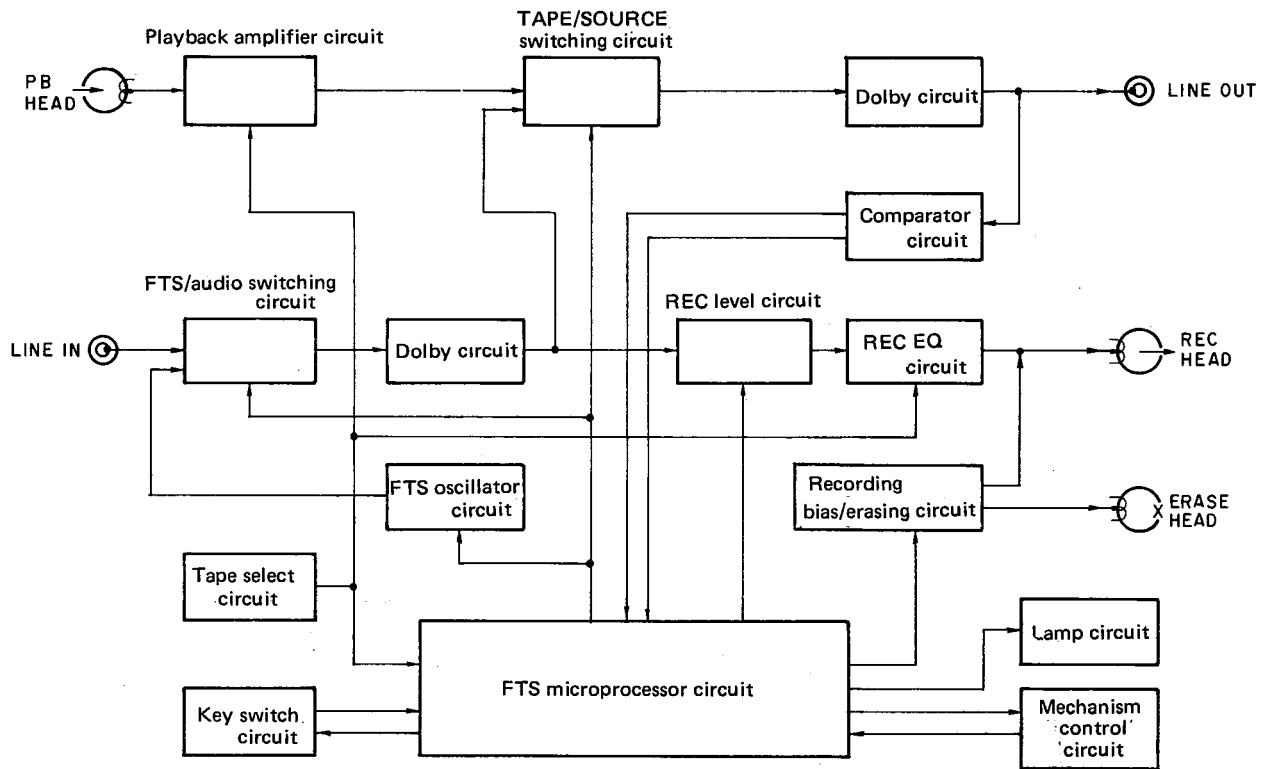

Block Diagram

1. FTS Function Outline

The outline of the FTS system, from start to finish will be explained in order of operations.

- (1) FTS start (0 sec.)
When the FTS START button is pressed, the START/FTS lamp will flash and the operation begins.
- (2) Detection of the tape magnetic coating (0-10 sec.)
If the magnetic coating on the tape is detected within 10 seconds after the FTS START button is pressed, the operation moves to the next item. However, when the magnetic coating is not detected within 10 sec. the FTS operation is stopped; the preset standard bias/recording sensitivity is set and the PRESET lamp is lit.
- (3) Stand-by run (approx. 1 sec.)
After detecting the magnetic coating, the tape is run for approximately 1 sec. before going to the next operation.
- (4) First sensitivity adjustment (approx. 1 sec.)
A reference signal of 1 KHz - 38 dB, generated from the FTS oscillator is recorded and played back. The sensitivity D/A is adjusted so that the normal output level of -20 dB is obtained.
- (5) Bias adjustment (approx. 1 sec.)
A reference signal of 12 KHz - 38 dB, generated from the FTS oscillator is recorded and played back. The sensitivity D/A is adjusted so that the normal output level of -20 dB is obtained.
- (6) Second sensitivity adjustment (approx. 1 sec.)
The same operation as the first sensitivity adjustment is carried out.
- (7) FTS finish
The tape is rewound to the FTS starting point; the mechanism is stopped and the START/FTS lamp is lit, completing the FTS operations.

2. The Main Functions of the FTS Microprocessor

The main functions of the microprocessor for each item listed above will be explained. Also refer to the Microprocessor Terminal Function Chart.

- (1) FTS start
 - 1) When the $\overline{\text{KM}}$ input terminal 1 detects the FTS START button being pressed, the FTS oscillator is operated by the H signal which comes out from the FTS/Audio terminal 10. After this, the START/FTS lamp is flashed by the pulse signal which comes out from the FTS lamp output terminal 12.
 - 2) The mechanism is set to the REC/PLAY mode by the active L control pulse signal which comes out from the $\overline{\text{REC}}$ output terminal 6 and the $\overline{\text{PLAY}}$ output terminal 7.
 - 3) The $\overline{\text{REC}}$ check terminal 26 (L) and the PLAY check terminal 27 (H) confirms the mechanism in the REC/PLAY mode, and this operation is finished. If the FTS START button is pressed within 5 seconds of turning on the power supply, the FTS will not operate.

- (2) Detection of the tape magnetic coating
 - 1) The sensitivity data output is set to $\overline{\text{FH}}$ (36 - 39 : L) and the bias data output to FH (32 - 35 : H), setting them to the maximum recording level.
 - 2) The sensitivity comparison signal, which becomes L when the magnetic coating is detected, is confirmed* at the sensitivity comparison terminal 40.
- (3) Stand-by run
The tape is run for approximately 1 second with the sensitivity data output set at $\overline{8\text{H}}$ (36 - 38 : H, 39 : L), and the bias data output at 8H (32 - 34 : L, 35 : H).
- (4) First sensitivity adjustment
 - 1) The bias data output is set to 8H (32 - 34 : L, 35 : H).
 - 2) The sensitivity comparison data is taken in from the sensitivity comparison terminal 40, and the sensitivity adjustment is performed.
- (5) Bias adjustments
 - 1) The sensitivity data output is set to the sensitivity adjustment value obtained in item (4).
 - 2) The bias comparison data is taken in from the bias comparison terminal 41, and the bias adjustment is performed.
- (6) Second sensitivity adjustment
 - 1) The bias data output is set to the bias value obtained in item (5).
 - 2) The sensitivity comparison data is taken in from the sensitivity comparison terminal 40, and the sensitivity adjustment is performed again.
- (7) FTS finish
 - 1) The mechanism is set to the RWD mode by the active L control pulse signal which comes out from the $\overline{\text{RWD}}$ output terminal 9.
 - 2) The RWD check terminal 28 (H) confirms* the mechanism in the RWD mode.
 - 3) After the tape has been rewound for the number of pulse counts taken in from the TAPE COUNT terminal 31 from the FTS start to just before RWD, the mechanism is set to the STOP mode by the active L control pulse signal which comes out from the $\overline{\text{STOP}}$ output terminal 8.
 - 4) After the internal oscillator is stopped by the L signal which comes out from the FTS/Audio terminal 10, the START/FTS lamp is changed to lit from flashing by the H signal which comes out from the FTS lamp output terminal 12, and the entire operation is completed.

*Confirm

The confirmation time is a maximum of approximately 10 seconds. If the designated mode cannot be confirmed within this time, the preset data output is made and the operation is completed.

TERMINAL FUNCTION CHART

Terminal No.	Name	Input/Output	Function
1	$\overline{\text{KM}}$	Input	Mode distinction key input
2	KM0	Output	FTS start clock output
3	KM1	Output	Preset out clock output
4	KM2	Output	Memory out clock output
5	KM3	Output	Memory mode clock output
6	$\overline{\text{REC}}$ output	Output	Active L 200 mS REC control pulse output
7	$\overline{\text{PLAY}}$ output	Output	Active L 200 mS PLAY control pulse output
8	$\overline{\text{STOP}}$ output	Output	Active L 200 mS STOP control pulse output
9	$\overline{\text{RWD}}$ output	Output	Active L 200 mS RWD control pulse output
10	FTS/Audio	Output	FTS \rightarrow H, Audio \rightarrow L
11	HOLD RESET	Output	Active H 3 mS output pulse to reset the playback hold
12	FTS LAMP	Output	During FTS \rightarrow Clock pulse output FTS DATA output is made \rightarrow H
13	PRESET LAMP	Output	PRESET DATA output is made \rightarrow H
14	NC	—	NON CONNECTION
15	RESET	Input	RESET input terminal
16	GND	Output	GND
17	OSC 1	Input	Internal oscillator excitation
18	OSC 2	Input	Terminal
19	CE	Input	Data maintenance; 5V
20	$\overline{\text{TEST}}$	Input	Microprocessor test; 3V
21	VDD	Input	VDD; 5V
22	$\overline{\text{LH}}$ memory	Input	Active L with LH memory designated input
23	$\overline{\text{FeCr}}$ memory	Input	Active L with FeCr memory designated input

Terminal No.	Name	Input/Output	Function
24	$\overline{\text{CrO}_2}$ memory	Input	Active L with CrO ₂ memory designated input
25	$\overline{\text{METAL}}$ memory	Input	Active L with METAL memory designated input
26	$\overline{\text{REC}}$ check	Input	Active L with REC check input
27	$\overline{\text{PLAY}}$ check	Input	Active H with PLAY check input
28	$\overline{\text{RWD}}$ check	Input	Active H with RWD check input
29	$\overline{\text{STOP}}$ check	Input	Active H with STOP check input
30	$\overline{\text{STOP}}$ sense	Input	When an H input is made at the STOP sense input, the FTS operation is stopped.
31	TAPE COUNT	Input	Pulse taken in from the tape counter
32	BIAS D ₀	Output	(LSB) } Data output for BIAS adjustments
33	BIAS D ₁	Output	
34	BIAS D ₂	Output	
35	BIAS D ₃	Output	
36	Sensitivity D ₀	Output	(LSB) } Data output for sensitivity adjustments
37	Sensitivity D ₁	Output	
38	Sensitivity D ₂	Output	
39	Sensitivity D ₃	Output	
40	Sensitivity comparison	Input	Sensitivity comparison data input
41	Bias comparison	Input	Bias comparison data input
42	$\overline{\text{Timer}}$	Input	Active L timer sense input

DISASSEMBLY INSTRUCTIONS

1. How to Remove the Front Panel

- (1) Remove the six screws 303 from both sides of the top cover 239, and take off the top cover.
- (2) Press the EJECT button 220 and open the cassette compartment. Push the cassette window 203 upward to remove from the cassette compartment. Return the cassette compartment to the original position.
Note: Be careful when handling the cassette window, as it is easily scratched.
- (3) Pull out the knobs 211, 212, 213, 214, 215.
Note: Be careful not to scratch the knobs and the clear plastic parts.
- (4) Unscrew the four upper screws 300 and the four lower screws 301 of the front panel 202; pull the front panel forward.

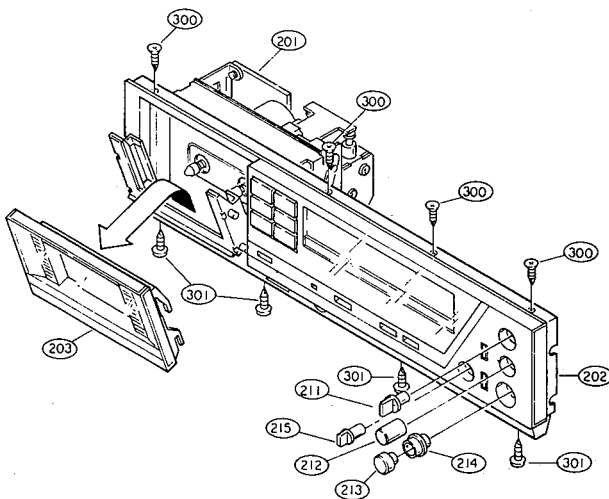

2. How to Remove the Control Switch Circuit Board and the FTS Switch Circuit Board (DR-F7/F8)

- (1) Remove the front panel 202.
- (2) The control switch circuit board and the FTS switch circuit board can be removed when the circuit board holding screws 305, behind the front panel, are unscrewed.

Note: When assembling, make sure the cushions 210 and 217 in between the switches and the buttons are inserted into the guides of the front panel 202.

Poor button operations may result if the cushions are not properly placed into the guides.

3. How to Remove the Mechanisms

- (1) Remove the top cover 239 and the front panel 202.
- (2) Unscrew the Hall IC circuit board holding screw 304 and take out the circuit board.
- (3) Remove the belt from the counter 224.

- (4) Pull the push lever (G) 245 forward to remove it from the Dolby switch 279. Unscrew the three Dolby circuit board 278 holding screws 304 and lift the circuit board upward.
- (5) Disconnect the connectors with the lead wires, which are connected to the mechanism, from the three places on the audio circuit board and two places on the logic circuit board.
Note: The orange line is the (R) channel and the white line is the (L) channel for the two 2P connectors used on the audio circuit boards. Make sure the connections are correct when assembling.
- (6) Unscrew the four holding screws 306 in the front section of the front chassis 226 and the two bottom cover 231 holding screws; by lifting, the mechanism unit can be taken out.
- (7) When assembling, the gap between the Hall IC and the counter magnet should be 0.5-1 mm.

4. How to Remove the Logic Circuit Board

Removing the three logic circuit board 280 holding screws 304 and the two screws holding the radiator 248 and the center angle 229 to lift out the logic circuit board.

5. How to Remove the Dolby Circuit Board

- (1) Remove the top cover 239.
- (2) Remove the front panel 202 and the various knobs 211, 212, 213, 214, 215.
- (3) Remove the push lever (G) 245 from the Dolby switch 279 and unscrew the four Dolby circuit board holding screws 304 to take out the Dolby circuit board.

6. How to Remove the Audio Circuit Board. () denotes DR-F6

- (1) Remove the Dolby circuit board together with the hinge.
- (2) Unscrew the selector switch 261 holding screws and the nuts from the volumes 262, 263. (Remove the nut from volume 263.)
- (3) Unscrew the four screws 304 holding the audio circuit board 260, and take out the screws 306 and the nuts 311 at the rear of the vertical mounted circuit board. (Unscrew the five screws 304 holding the audio circuit board 260.)
- (4) The audio circuit board can be taken out by sliding it back and lifting.

Note: Most repairs to the logic and audio circuit boards can be done by removing the bottom cover. Refer to the above removal instructions as necessary.

7. Power Supply Section

Since the safety regulation applies to the power supply section, be careful of the parts used and the soldering of these parts when replacing.

ADJUSTING AND CHECKING THE MECHANISM SECTION

1. Replacing the Pinch Roller 31

Before replacing the pinch roller, clean the tape contact surface of the pinch roller and the capstan shaft 30.

Most causes of poor tape transport can be traced to dirty pinch rollers and capstan shafts.

By removing the pinch roller spring 33 and the 2.5E ring 139, the pinch roller 31 can be taken out, along with the pressure bracket. When assembling, always insert the pressure bracket 32 shaft into the long hole of the connecting lever 11 on the back side of the mechanism chassis 1.

After replacing, run a pad-less C-90 tape to check for tape curls at the tape guide section of the head.

2. Checking the Pressure Force of the Pinch Roller

In the playback mode, hook a dial tension meter (500 g) onto the bracket at the center of the pinch roller. After separating the pinch roller from the capstan shaft, allow the pinch roller to contact the capstan shaft again. Check to make sure the dial tension meter reads between 375-475 g when the pinch roller starts to rotate. If it is not within the normal range, replace the pinch roller spring.

Note: In the playback mode, check to make sure that there is a gap of more than 0.5 mm between the pinch roller bracket 31 and the pressure bracket 32.

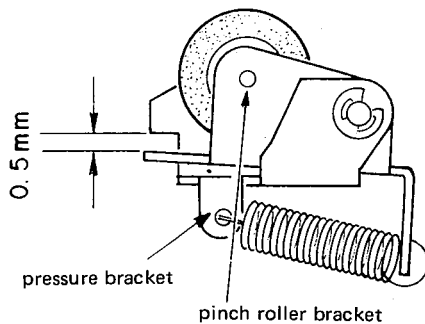

3. Replacing the Record/Playback Head

* Before replacing, remove the mechanism unit from the chassis.

(1) How to remove the R/P HEAD.

1) When the R/P HEAD holding screw 102 is taken out, be careful as the CORD CLAMPERS 49 and 47 as well as the 3T-LUG with the wire will come off.

Next, take out the azimuth adjustment NUT 159 and the height adjustment ORDER SCREW 39 loosening them alternately.

If they are not loosened alternately, the R/P HEAD base may become warped.

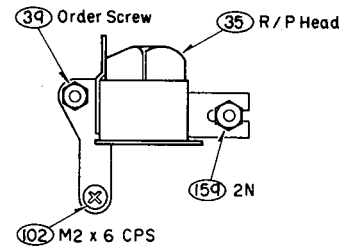

2) By unsoldering the HEAD WIRES on the circuit board section of the R/P HEAD, the entire R/P HEAD can be taken off the mechanism unit.

(2) How to assemble the R/P HEAD.

Reverse the above (1) procedures for removing the R/P HEAD.

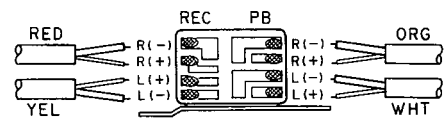

* Solder the HEAD WIRES according to the diagram above.

* In replacing the R/P HEAD, whenever possible, do not remove the WIRE CLAMPER, which holds the HEAD WIRES to the CORD CLAMPER 77. It is adjusted so that the HEAD WIRES do not become a load during the HEAD PLATE operations.

If the WIRE CLAMPER must be removed, after replacing the R/P HEAD, check to make sure that (1) the HEAD WIRES do not contact the pinch roller spring during the HEAD PLATE operations; (2) the HEAD WIRES are not creating a load at the bottom plate and that the HEAD PLATE lowers to the required position at the STOP mode.

4. Adjusting the R/P HEAD

(1) Height adjustments (Use the head adjusting jig M-300)

Set the M-300 tool plate on the mechanism unit; turn the height adjustment ORDER SCREW 39 and adjust so that the 3.8 mm measure section of the M-300 (tool grip) can pass without contacting the tape guide of the R/P HEAD 35.

- * Only the height adjustment is necessary; no tilt adjustments are required.
- * When adjusting the height, make sure the R/P HEAD is not tilted by turning the azimuth adjustment nut, and checking with your eyes.
- * Never allow the M-300 (tool grip) to hit the tape contact surface of the R/P HEAD strongly. It may scratch the surface.
- * After the height adjustments, replace the mechanism unit to the chassis and re-connect all connectors.

(2) Azimuth adjustments

Play back the TEAC MTT-114 test tape. Turn the azimuth adjustment nut and adjust so that A of the resurge wave form is maximum and B is minimum. After the azimuth adjustments, re-check the head height with the M-300 to make sure the height has not deviated.

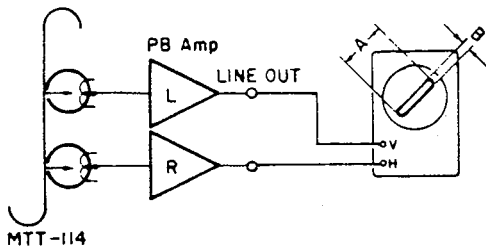

- * After the various adjustments, apply anaerobic adhesive on the positions indicated in the diagram.

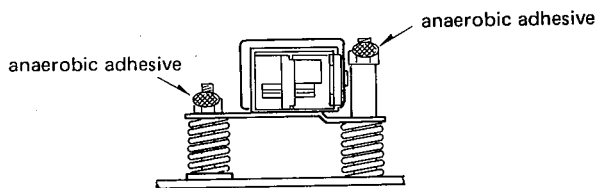

5. Replacing the ERASE HEAD 40 .

The ERASE HEAD can be replaced by removing the 2E ring 138 , which holds the detecting arm 46 , and the two ERASE HEAD holding screws 119 .

6. Adjusting the ERASE HEAD Height

After the washers 149 and 151 are properly placed as mentioned below, check the height of the ERASE HEAD tape guide section using the M-300 (tool grip).

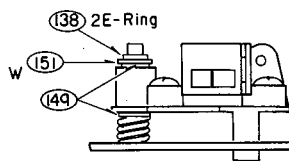

- * The above diagram illustrates the placement of the various washers under normal conditions. If the M-300 indicates that height adjustments are required, reverse the position of washer 151 and lower side washer 149 , or change the thickness of the upper side washer 149 to 0.13 mm and adjust the various washers so that the total thickness becomes the same. In this case, make sure that a poly washer is always placed above and below the boss section of the E. HEAD bracket 41 .

7. Adjusting the Gap Between the HEAD PLATE and the ERASE HEAD Bracket During Playback

Adjust the attachment position of the ERASE HEAD, making sure the gap between the ERASE HEAD bracket and the HEAD PLATE is 0.3-0.7 mm.

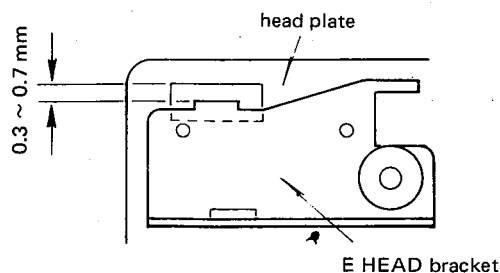

8. Adjusting the Gap Between the Detecting Arm 46 and the ERASE HEAD Bracket

With a cassette loaded, turn screw 104 and adjust to that the gap between the detecting arm and the ERASE HEAD bracket is 0.5-0.8 mm during playback. After adjusting, apply anaerobic adhesive as shown in the diagram.

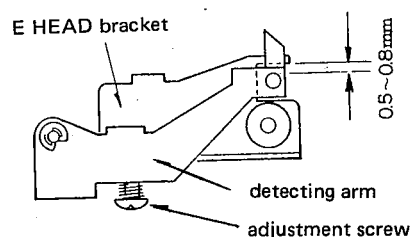

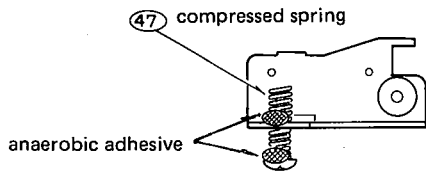

- * When replacing the E HEAD BRACKET 41, apply anaerobic adhesive at the bottom of the spring 47 to prevent it from falling, as shown in the diagram.

9. Checking for Axis Direction Movements of the Capstan Shaft

Hold the capstan shaft from the front of the mechanism and move it in the axis direction; check to make sure the movement is within 0.2-0.8 mm.

If it is not within this range, change the thickness of the poly washer 146. In addition, when replacing the flywheel, be careful of the positions of the poly washers 146 and 148.

10. Checking the Take-up Torque

Load the cassette type torque meter. Check to make sure that the torque meter average reading is within 35-60 g-cm during playback. If it is not within this range, check the voltage (3.4 V) of the reel motor. If the voltage is low, the torque will be weak; if it is high, the torque will be strong. In addition, check for reel thrust movement in section 11.

11. Adjusting the Reel Thrust Movement

Check to make sure that the reel thrust movement is within 0.2-0.4 mm. If it is not within this range, change the thickness of the washer 146, 0.25t, which is placed behind the reel. Do not reuse the holding washer 145.

12. Checking the FF and REW Torques

- * When using the cassette type torque meter. Check to make sure the torque meter indicates more than 80 g-cm at the end of FF and REW.
- * When using a modified cassette half. (See Service Manual "Model DR-230", page 12) Load the modified cassette half; hook the end of the dial tension meter (full scale 100-300 g) onto the triangle section. In the FF (REW) mode, feed the tape in at a rate somewhat slower than the take up speed. Check to make sure the dial tension meter reads more than 60 g-cm.

13. Checking the Back Tension Torque During Record/Playback

Load the cassette type torque meter; check to make sure the torque meter reads between 2-5 g-cm during playback and that there are no unevenness.

If it is not within this range, check the section on adjusting the reel thrust movement; or else replace the spring 53.

14. Checking the FF and REW Times

Load a C-60 cassette tape; check to make sure the tape is fast forwarded or rewound in between 60-100 seconds. If it is not within this range, check sections 11 and 13.

15. Adjusting the Position of the Erase Prevention Lever

Adjust the mounting position of the switch, so that when the cassette is loaded, switch 59 turns ON-OFF properly.

16. Checking the EJECT Switch 82.

To check the operation of the EJECT SW with only the mechanism unit, do so by attaching the EJECT LEVER 221.

17. Adjusting the Position or Replacing the Hall IC

Adjust the gap between the Hall IC and the outer edge of the magnet of the counter 224 to 0.5-1 mm, as shown in the diagram below.

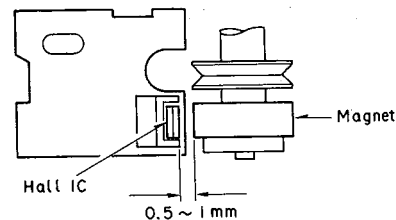

18. Checking the Position of the Counter Belt

After replacing the mechanism unit, check to make sure the counter belt is hooked in the position as shown in the diagram below.

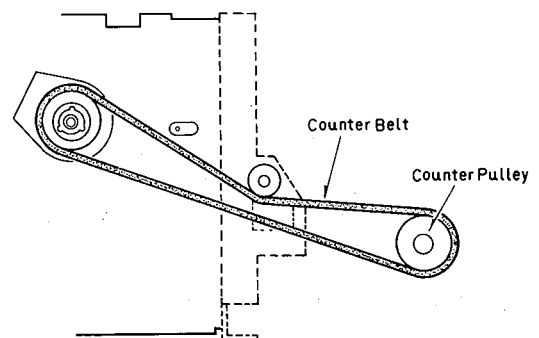

ADJUSTING THE ELECTRICAL SECTIONS

● Measuring instruments necessary for adjustments

- (1) Audio signal generator
- (2) Variable resistance attenuator
- (3) Vacuum tube voltmeter
- (4) Oscilloscope
- (5) Frequency counter
- (6) Adjustment screwdriver
- (7) Trap coil adjustment square stick
- (8) Test tapes (TEAC MTT-111, MTT-114, MTT-150, MTT-316 or 116K)
(MAXELL XL-II) C-46 or C-60
(DENON DX 3, DXM)
(COLUMBIA LX-C60)
- (9) Transport check cassette tape
(COLUMBIA C-120, modified)

● Cautions on adjusting

- (1) Before adjusting, clean the head surface, capstan and the pinch roller with a gauze or a cotton swab moistened with alcohol.
- (2) Demagnetize the R/P HEAD and the E.HEAD with a head eraser.
- (3) Completely demagnetize the adjustment screwdriver.
- (4) Unless instructed otherwise, set the various controls as follows:
 - INPUT volume maximum clockwise
 - OUTPUT LEVEL volume . . maximum clockwise
 - DOLBY NR switch OFF
 - TAPE SELECT switch CrO₂
 - MONITOR switch TAPE

1. Tape Transport Check

Load the transport check cassette. In the operational mode, illuminate the fixing guides of the R/P HEAD with a lamp and check to make sure the tape edge does not come in contact with the tape guide section.

The tape transport is the most important element in determining the performance of a cassette deck.

Avoid moving the various adjustment screws, nuts, etc., as much as possible. Refer to the pages on "Adjusting and Checking the Mechanism Section" when replacing or adjusting the R/P HEAD.

2. Adjusting the Azimuth

- (1) After completing the tape transport check, load the test tape (TEAC MTT-114).
- (2) Play back the test tape; adjust the azimuth screw so that section A of the resurge wave form is maximum and section B is minimum.

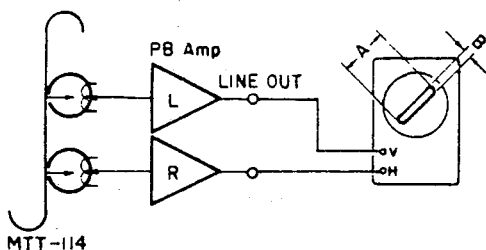

3. Checking and Adjusting the Tape Speed

- (1) (DR-F6/F7)
 - 1) Connect the frequency counter to the LINE OUT terminal and load the test tape (TEAC MTT-111).

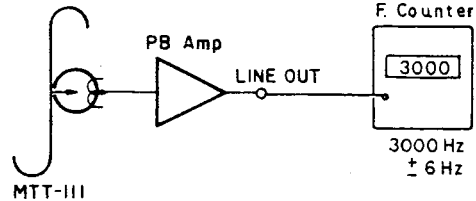

- 2) Play back the test tape; at the midpoint of the tape, where the transport is stable, adjust VR 1 of KU-0426 (DD MOTOR UNIT) so that the frequency counter reading is in the range of 3,000 Hz \pm 6Hz.

- (2) (DR-F8)

- 1) Adjusting the lock position
Measure the T.P. of KU-0434 (QUARTZ LOCK UNIT) with the oscilloscope and adjust VR 1 of KU-0426 (DD MOTOR UNIT) so that the duty is 50% (906 Hz).

At this time, LE 901 (red LED) of KU-0434 will light up.

- 2) Connect the frequency counter to the LINE OUT terminal and play back the test tape (TEAC MTT-111). Check to make sure the frequency counter reading is in the range of 3,000 Hz \pm 6 Hz.

4. Adjusting the Input Sensitivity

- (1) Set the MONITOR switch to SOURCE position, the operational mode at STOP. Supply a 400 Hz signal using audio signal generator to the LINE IN terminal and set the input signal level (approx. -18 dB) so that the output level at the test point TP 51 (L ch) on the Dolby circuit board becomes -2.5 dB.
- (2) Adjust Vr 301 on the audio circuit board so that the output level at the test point TP 61 (R ch) on the Dolby circuit board becomes -2.5 dB. In the case of DR-F6, adjust Vr 204.

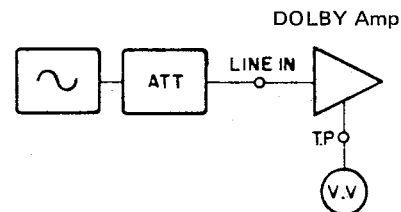

5. Adjusting the Dolby Circuit Board (KU-0423)

- (1) Supply a 400 Hz signal to the LINE IN terminal and set the input level so that the levels at the test points TP 51 (L ch), TP 61 (R ch) become -22.5 dB.
- (2) Adjust Vr 501 (L ch), Vr 601 (R ch) so that the levels at test points TP 52 (L ch), TP 62 (R ch) becomes -22.5 dB.
- (3) Next, check to make sure that the levels at the test points TP 53 (L ch), TP 63 (R ch) are -22.5 dB \pm 0.5 dB.
- (4) Adjust Vr 502 (L ch), Vr 602 (R ch) so that the levels at the test points TP 54 (L ch), TP 64 (R ch) becomes -22.5 dB.
- (5) Check to make sure that the overall frequency response meets the specifications in the diagram below.

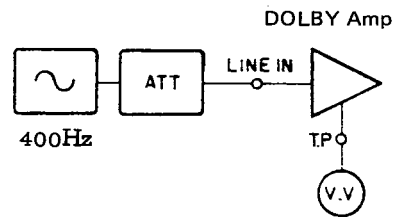

Dolby Circuit Board Back to Back Frequency Response

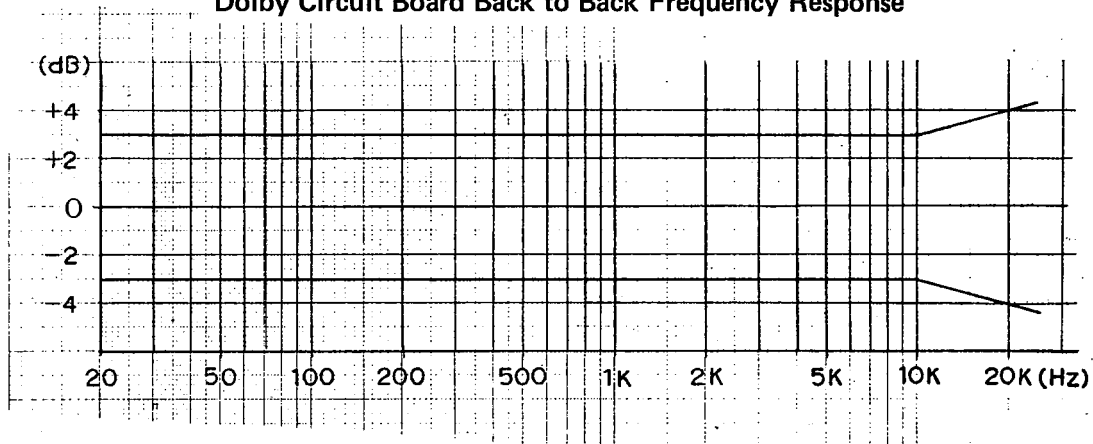

6. Adjusting the Playback Section

- (1) Adjusting the playback level
Play back the Dolby standard level test tape (TEAC MTT-150) and adjust Vr 101 (L ch), Vr 201 (R ch) so that the LINE OUT voltage becomes 0 dB (0.775 V).
- (2) Adjusting the playback frequency response
Play back the test tape (TEAC MTT-316 or 116K) and adjust Vr 102 (L ch), Vr 202 (R ch) so that the frequency response meets the specifications in the diagram.

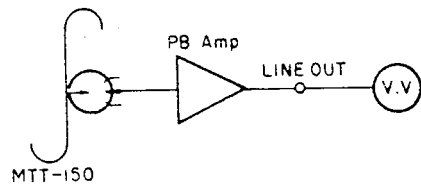

Playback Frequency Response

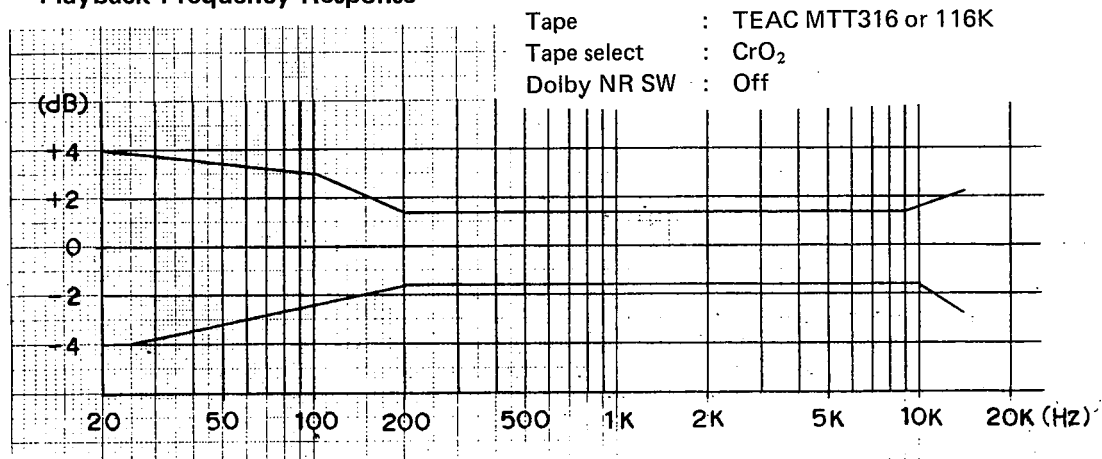

7. Adjusting the Meter

After adjusting the playback level, play back the test tape (TEAC MTT-150) and adjust Vr 103 (L ch), Vr 203 (R ch) so that the VU meter indicates +3 VU when the LINE OUT voltage is 0 dB (0.775 V).

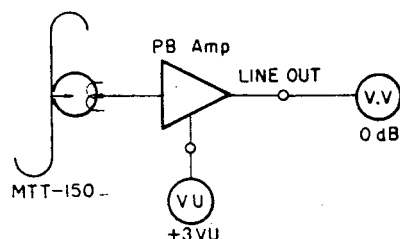

8. Adjusting the Recording Section

(1) Adjusting the record/playback overall frequency response.

- 1) Load the test tape MAXELL XL-II (C-60); record a signal with an input level of -38 dB, 1 KHz at the LINE IN terminal; play back this recording.
- 2) Change the frequency of the input signal from 1 KHz to 12 KHz with same levels -38 dB; record and play back; adjust Vr 106 (L ch), Vr 206 (R ch) so that the output level is about equal compared to the 1 KHz signal output level. In the case of DR-F6, adjust Vr 402 (L ch), Vr 502 (R ch). Check to make sure that the overall frequency response meets the specifications in the diagram below.

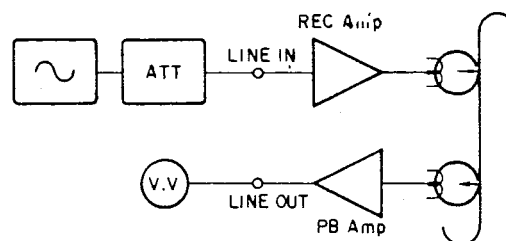

Record/Playback Overall Frequency Response

Tape : MAXELL XL-II C-60
 Tape Select : CrO₂
 Dolby NR SW : Off
 Level : Dolby level - 20dB

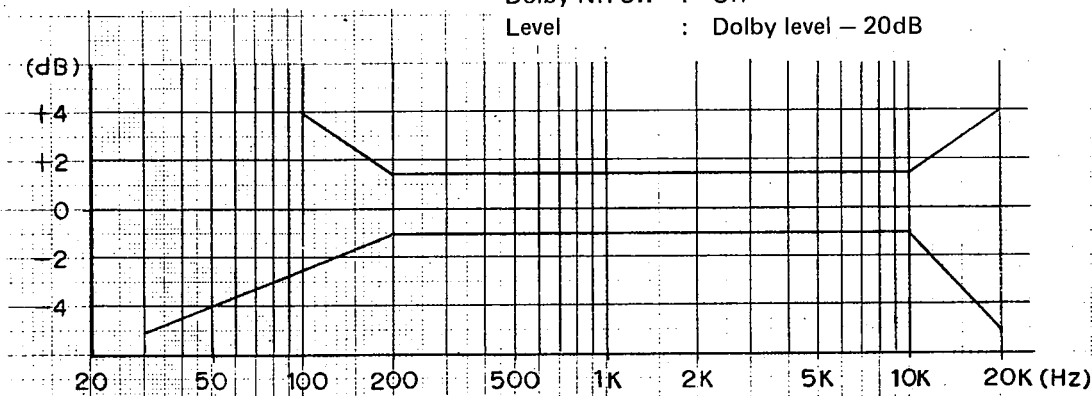

(2) Adjusting the record/playback levels

- 1) Load the test tape MAXELL XL-II (C-60) and record a signal of 1 KHz (-38 dB).
- 2) Adjust Vr 105 (L ch), Vr 205 (R ch) so that the output level is the same when the MONITOR switch is switched from SOURCE to TAPE position. In the case of DR-F6, adjust Vr 401 (L ch), Vr 501 (R ch).

(3) Checking the Dolby C record/playback overall frequency response

- 1) Set the DOLBY NR switch to the "C" position.
- 2) Using the test tapes DXM, XL-II, DX-3, perform record/playback in the same manner as 8-(1).
- 3) Check to make sure that the record/playback overall frequency response meets the specifications in the diagram.

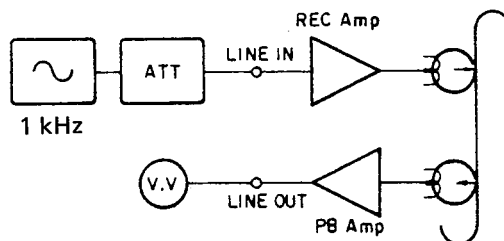

Dolby C Record/Playback Overall Frequency Response.

Tape : XL-II, DX3, DXM
 Tape Select : CrO₂, NORMAL, METAL
 Dolby NR SW : C
 Level : Dolby level - 20dB

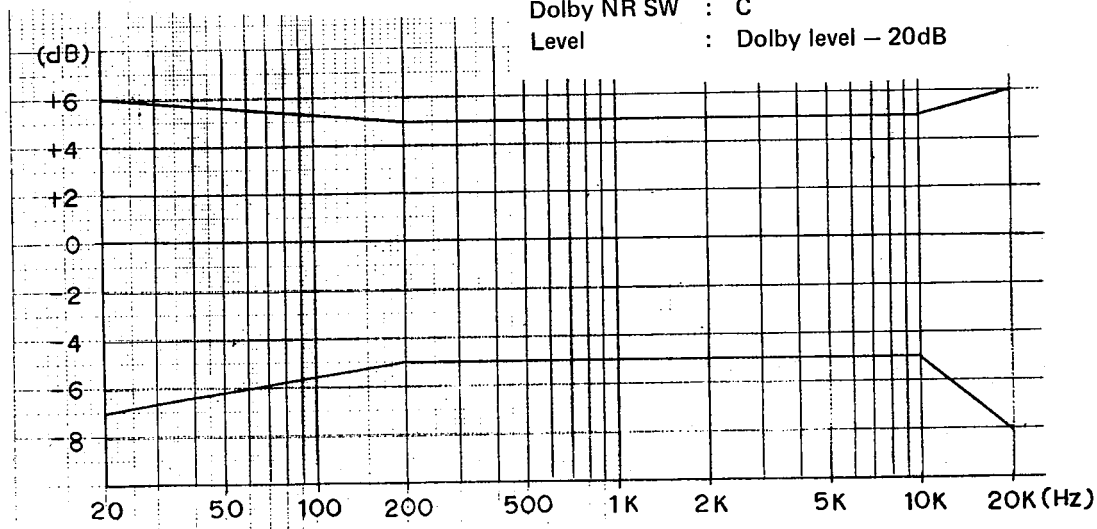

9. Adjusting the FTS Section (DR-F7/F8)

(1) Adjusting the FTS test signal, oscillator

- 1) Supply a -38 dB, 1 KHz signal to the LINE IN (L) terminal and read the level at the REC OUT (L) terminal.
- 2) Press the FTS START button to switch over to the FTS test signal. Adjust Vr 104 so that the level after the switch-over is the same as the value read in 9-(1)-1).
- 3) Supply a -38 dB, 12 KHz signal to the LINE IN (R) terminal and read the level at the REC OUT (R) terminal.
- 4) Press the FTS START button to switch-over to the FTS test signal. Adjust Vr 204 so that the level after the switch-over is the same as the value read in 9-(1)-3).

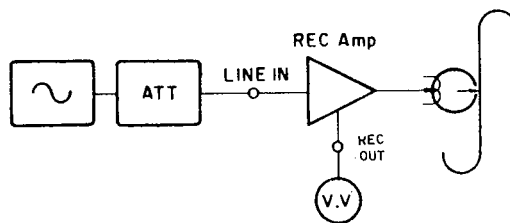

(2) Adjusting the reference level of the FTS comparator circuit

Supply a -38 dB, 1 KHz signal to the LINE IN terminal and adjust Vr 302 so that the level at the test point TP 31 is set immediately after H → L or L → H alteration.

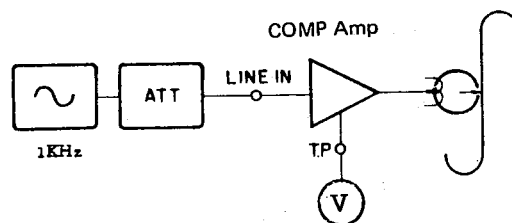

(3) Checking the FTS operations

- 1) Set the TAPE SELECT switch to the NORMAL position and load a tape (LX-C60).
- 2) Light up the PRESET LAMP, setting the unit in the PRESET mode. Record and play back 1 KHz and 12 KHz signals at -38 dB, and take a note of the frequency response.
- 3) Press the FTS START button. After completion, (check the lit FTS lamp) record and play back the 1 KHz and 12 KHz signals at -38 dB. Check to make sure that the frequency response is improved when compared to the ones noted in 9-(3)-2).

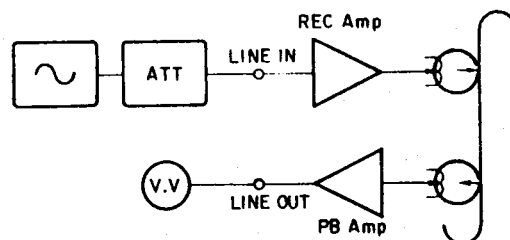

● Beat Interference

Beat interference may result if the unit is used close to an AM tuner. In this case separate the distance between the tuner and the cassette deck.

PARTS LIST OF MECHANISM UNIT

Ref. No.	Part No.	Part Name	Remarks
1	9J250101F	MECH. CHASSIS ASS'Y	
2	9J250131	FELT	
3	9J250112A	C. SUPPORT SPRING	
4	9J250113	SPRING PLATE	
5	9J250219	BRAKE	
6	9J250275	BRAKE SHOE	
7	9J250209	HEAD SLIDER ASS'Y	
8	9J250288	BRAKE SPRING	
9	9J2502010	BRAKE SLIDERS ASS'Y	
10	9J2502103	BRAKE LEVER	
11	9J2502104	CONNECTING LEVER	
12	9J2502802	SPRING	
13	9J250289	SPRING	
14	9J2502011	S. LEVER ASS'Y	
15	9J2502012	S. BRACKET ASS'Y	
16	9J250272	SIDE STOPPER	
17	2148062005	SOLENOID (A)	
18	2148062018	SOLENOID (B)	25-02-93A
19	9J250249	SHAFT	25-02-93B
20	KU-0426	D.D UNIT	
	KU-0426-1	D.D UNIT	DR-F8 only
21	9J250295	STATOR COIL ASS'Y	
22	2680033000	H-200A (PNK)	25-02-96
23	9J2502105	SHIELD PLATE	25-02-105
24	9J2502106	BRACKET	
25	9J250304	BEARING ASS'Y	
26	9J250311	FG. YOKE	
27	9J250312	FG. GENERATER (B)	
28	9J250391	FG. MAGNET	
29	9J250392	FG. COIL ASS'Y	
30	9J250307	FLY WHEEL ASS'Y	
31	9J250401	P. ROLLER BRACKET ASS'Y	
32	9J250402	PRESSURE BRACKET ASS'Y	
33	9J250481	P. ROLLER SPRING	
34	9J250505	HEAD PLATE ASS'Y	
35	3918051009	R/P HEAD	25-05-99
36	9J250598	WIRE ASS'Y	
37	9J250584	SPRING	
38	9J250588	SPRING	
39	9J2505502	ORDER SCREW	
40	3918031003	E. HEAD	25-05-92
41	9J250503	E. HEAD BRACKET ASS'Y	
42	9J250582A	TOSION SPRING	
43	9J250583	ADJUST SPRING	
44	9J250514	SPRING PLATE	
45	9J250515	BRACKET	
46	9J250506	DETECTING ARM ASS'Y	

Ref. No.	Part No.	Part Name	Remarks
47	9J250587	SPRING	
48	9J250597	LUG	
49	9J11140302	LUG	
50	9J250709	REEL BASE ASS'Y	
51	9J2507010	REEL ASS'Y	
52	9J250722	SPRING SUPPORT	
53	9J2507801	SUPPLY SPRING	
54	2178061209	REEL MOTOR UNIT	25-07-93
55	9JSIE14007	IDLER	S1E14007
56	9J191471	COUNTER BELT	
57	9J251302	REC LEVER ASS'Y	
58	9J251381	TORSION SPRING	
59	9J251791	SWITCH	
60	9J2517120	EJECT LEVER (B)	
61	9J251783	SPRING	
62	9J201703	DAMPER PISTON ASS'Y	
63	9J201761	DAMPER CYLINDER	
64	9J2517118	DAMPER ARM	
65	9J2517122	E.S.C PLATE	
66	9J2517113	CASSETTE BOX	
67	9J251761	CASSETTE HOLDER (R)	
68	9J251762	CASSETTE HOLDER (L)	
69	9J251717	C. PRESSURE SPRING	
70	9J181705	HINGE (L) ASS'Y	
71	9J2517013	HINGE (R) ASS'Y	
72	9J251753A	BOSS	
73	9J251785	TORSION SPRING	
74	9J2517121	EJECT LEVER (C)	
75	9J250282	SPRING	
76	9J251764	LAMP LENS	
77	9J04681	LUG	
78	9J251706	SIDE BRACKET (L) ASS'Y	
79	9J251752	ROLLER	
80	9J251793	LAMP	
81	9J251771	LAMP COVER	
82	9J251391	EJECT SWITCH	
83	9J251709	SIDE BRACKET ASS'Y	
84	9J191463	PULLEY	
85	9J2517011	EJECT ARM	
101	9JDRF101	CPS 2x2	SCPMS2002
102	4711103014	CPS 2x6	
103	9JDRF103	CPS 2x7	
104	4711810006	CPS 2x10	
105	4711201013	CPS 2.6x4	
107	4711301010	CPS 3x4	
108	9JDRF208	2.6x4 FT	SCPTS2604
109	9JDRF110	2.6x5 FT	SCPTS2605
112	4713101014	CBS 2x4	

PARTS LIST OF EXPLODED VIEW

Ref. No.	Parts No.	Part Name	Remark
113	4713801000	CBS 2x10	
114	4713203019	CBS 2.6x6	
115	4713204018	CBS 2.6x8	
116	4713206016	CBX 2.6x12	
119	4714102012	CTS 2x5	
121	9JDRF112	CPTS 2x6	SCPTB2006
122	4733800007	CBTS 3x6	
123	4733800010	CBTS 3x8	
126	9JDRF226	CUP P TITE 2x10	
127	9JDRF227	CUP S TITE 3x6	
128	9JDRF228	CBS 2.6x6	
130	4700002003	CPS 2.6x5 (SW)	
131	4700003002	CPS 2.6x6 (SW)	
134	4712802013	CFS 2x4	
135	9JDRF235	CFS 2.6x5 (NIBP)	BCFMS2605
138	4761000002	1.5E RING	
139	9JDRF123	1.9E RING	E1R900000
140	9JDRF124	2.3E RING	E2R300000
121	9JDRF112	CPTS 2x6	SCPTB2006
122	4733800007	CBTS 3x6	
123	4733800010	CBTS 3x8	
126	9JDRF226	CUP P TITE 2x10	
127	9JDRF227	CUP S TITE 3x6	
128	9JDRF228	CBS 2.6x6	
130	4700002003	CPS 2.6x5 (SW)	
131	4700003002	CPS 2.6x6 (SW)	
134	4712802013	CFS 2x4	
135	9JDRF235	CFS 2.6x5 (NIBP)	BCFMS2605
138	4761000002	1.5E RING	
139	9JDRF123	1.9E RING	E1R900000
140	9JDRF124	2.3E RING	E2R300000
142	9JDRF138	NYLON φ2.4x6xt0.5	NYW240650
143	9JSEE10227	NYLON φ1.2x3xt0.25	SEE10227
144	9JDRF244	NYLON φ1.7x4xt0.25	
145	9JDRF134	NYLON φ2x4xt0.5	GNW200450
146	9JDRF246	NYLON φ2.5x5xt0.25	GNW260525
148	9JDRF248	NYLON φ2.5x8xt0.25	GNW260825
149	9JDRF133	NYLON φ2x4xt0.25	GNW200425
151	9JDRF143	WASHER φ2x4xt0.25	SFW204030
153	9JDRF253	SPASER φ2x3xL1.6	
154	9JDRF254	SPASER φ2.6x3.6xL4.5	
155	9JDRF255	SPASER φ3x4xL3.5	
157	9JDRF121	φ2 STEEL BALL	SSB020000
159	4756020000	2N	

Ref. No.	Part No.	Part Name	Remarks
201	3388009005	V. MECHA (31) UNIT	DR-F6/F7 only
	3388010007	V. MECHA (32) UNIT	DR-F8 only
202	1038188320	FRONT PANEL ASS'Y	DR-F6 only
	1038188304	FRONT PANEL ASS'Y	DR-F7 only
	1038188317	FRONT PANEL ASS'Y	DR-F8 only
203	1038193001	CASSETTE WINDOW ASS'Y	
204	1038191210	CONTROL BUTTON ASS'Y	
205	1038191207	CONTROL BUTTON ASS'Y	
206	1038191252	CONTROL BUTTON ASS'Y	
207	1038191223	CONTROL BUTTON ASS'Y	
208	1038191249	CONTROL BUTTON ASS'Y	
209	1038191236	CONTROL BUTTON ASS'Y	
210	4618108002	CUSHION (A)	
211	1128084208	V. KNOB (D)	
212	1128086002	V. KNOB (C) ASS'Y	
213	1128082103	V. KNOB (A) ASS'Y	
214	1128083209	V. KNOB (B) Ass'y	
215	1128087001	V. KNOB (E)	
216	1138133000	AUTO BIAS KNOB	DR-F7/F8 only
217	4618109001	CUSHION (B)	DR-F7/F8 only
218	1138132205	POWER KNOB	
219	1138107201	PUSH KNOB	
220	1138107214	PUSH KNOB	
221	9J2517119	EJECT LEVER	
222	9J250281	EJECT SPRING	
223	1138131206	SLIDE KNOB	
224	4598012001	TAPE COUNTER	
225	2158023102	LEVEL METER	
	9240002005	METER LAMP	
226	4118255303	FRONT CHASSIS	
227	4118256302	SIDE ANGLE (L)	
228	4118257204	SIDE ANGLE (R)	
229	4118258300	CENTER ANGLE	
230	4128522408	TRANS BRACKET	EU, EC, E1 only
	4128679005	TRANS BRACKET ASS'Y	E2, EG, EF, EA, EK only
231	1058079309	BOTOM COVER	
232	4118263007	P.C.B. BRACKET (B)	
233	1028265208	SIDE ESC.	
234	4128523106	P. SWITCH BRACKET	
235	1048065006	FOOT	
236	1058080204	BACK PANEL	
	1058087003	BACK PANEL	E1 only
△ 237	2339052002	POWER TRANS	EU, EC only
	2339053108	POWER TRANS	E2, EG, EF only
	2339053111	POWER TRANS	EA, EK only
	2339054000	POWER TRANS	E1 only
238	4128675009	P.C.B. HING ASS'Y	
239	1028263200	TOP COVER ASS'Y	
△ 240	2129136015	POWER SWITCH	
	2129136028	POWER SWITCH	EU, EC only
△ 241	2618006009	SPARK KILLER	EU, EC only
242	2049628001	4P CONNECTOR BASE	DR-F6/F7 only
	2049631001	4P WRAPPING JACK	DR-F8 only
△ 243	2062019008	AC CORD WITH PLUG	EU, EC only
	2062002031	AC CORD WITH PLUG	E2, EG, EF only
	2006031026	AC CORD WITH PLUG	E1 only
	2006019310	AS 3P AC CORD	EA only
	2062024006	AC CORD WITH LABEL	EK only
△ 244	MD-3802	BUSHING	EU, EC, E1 only
	4450018004	BUSHING	E2, EG, EF, EK only
	MD-2982H	CORD BUSH	EA only

ACCESSORIES GROUP

Ref. No.	Part No.	Part Name	Remarks
245	4318064200	PUSH LEVER (G)	
246	4318056302	PUSH LEVER (D)	
248	4178076108	HEAT SINK (U)	
249	4498055003	LED SUPPORT (A)	
250	4150089003	P.C.B. SUPPORT	E2, EG, EF, EA, EK, E1 only
251	KU-0446	POWER WIRING UNIT	E2, EG, EF, EA, EK only
	KU-0447	POWER WIRING UNIT	E1 only
252	2123315023	VOLTAGE SELECTOR	E1 only
253	4418748002	FIXING BRACKET	EU, EC, E2, EG, EF, EA, EK only DR-F8 only
259	KU-0434	QUARTZ LOCKED UNIT	
260	KU-0435	AUDIO AMP UNIT	DR-F6 only
	KU-0422	AUDIO AMP UNIT	DR-F7/F8 only
261	2123330008	SWITCH CONTROL UNIT	DR-F6 only
	2129178002	SELECTOR SWITCH	DR-F7/F8 only
262	2118067001	V1620V30KA103	
263	2118070014	V1611V35KA203	
264	2049627002	MIC JACK	
265	2049626003	HEADPHONE JACK	
266	KU-422B	TUNING DISPLAY UNIT	DR-F7/F8 only
267	2129130008	PUSH SWITCH	
268	3939095109	LED	DR-F7/F8 only
269	2123329006	ROTARY SWITCH	
270	3939094100	LED	
271	3939096108	LED	
272	3939095109	LED	
273	4498058204	LED SUPPORT (C)	
274	2129181002	SWITCH CONTROL UNIT	DR-F6 only
	2129145006	PUSH SWITCH	DR-F7/F8 only
275	3939148001	LED (RED)	
276	3939148014	LED (GRN)	
277	3939148027	LED (YEL)	
278	KU-0423	DOLBY B/C UNIT	
279	2129145006	PUSH SWITCH	
280	KU-0421	LOGIC UNIT	
281	2129179001	SLIDE SWITCH	
282	2049624319	8P JACK	
283	2680028002	DN-6838	
284	4498059106	HALL IC GUIDE	
285	4358021009	FLEX WIRE	DR-F6 only
286	4358020013	FLEX WIRE	DR-F6 only
300	4732800008	3x6 CFTS	
301	4730353023	3x6 CBRTS	
302	4730304030	3x8 CBRTS	
303	4734801005	4x8 CTTS	
304	4733800007	3x6 CBTS	
305	4734304014	3x8 CBRTS	
306	4713303016	3x6 CBS	
307	4712201054	2.6x4 CFS	
308	4730253013	2.6x6 CPTS	
309	4739014017	4x8 CBTS	
310	4730453017	4x6 CBRTS	
311	4756006008	3N	DR-F7/F8 only
313	4751003006	3W	
314	4713203035	2.6x6 CBS	E1 only
315	4756004000	2.6N	E1 only
316	4739013018	4x6 CPTS (FT)	EU, EC only
	4739015016	4x10 CPTS (FT)	E2, EG, EF, EA, E1, EK only
317	4753002005	4TWA	
318	4751105014	4W	

Ref. No.	Part No.	Part Name	Remarks
	5118205006	INSTRUCTION MANUAL	EU, EC, E2, EA, E1, EK only
	5118206005	INSTRUCTION MANUAL	EG only
	5118207004	INSTRUCTION MANUAL	EF only
	2032024418	2P CONNECTOR CORD	DR-F6/F7 only
	2033666008	2P CONNECTOR CORD	DR-F8 only
	PC-3244	ENVELOPE	

CARTON CASE GROUP

Ref. No.	Part No.	Part Name	Remarks
	5018248118	CARTON CASE	DR-F6 only
	5018248105	CARTON CASE	DR-F7 only
	5018248121	CARTON CASE	DR-F8 only
	5048020005	PROTECTOR	
	5038038201	PACKING	
	5058092007	RAMINATE COVER	
	5038041007	CUSHION	

Remark symbols in the parts list refer to the following countries and areas.

- EA: Australia
- EK: United Kingdom
- EU: U.S.A.
- E1: Multiple voltage model
- E2: European continent
- EF: French
- EG: German
- EC: Canada

WARNING:

Parts marked with  and/or shading have special characteristics important to safety. Be sure to use the specified parts for replacement.

KU-0435 AUDIO AMP UNIT (DR-F6) Only

Ref. No.	Part No.	Part Name	Remarks
SEMICONDUCTOR GROUP			
IC301, 302 304, 305 IC303	2630189001 2630092004	M5218L LB1416	
IC101, 201 TR304	2650029002 2710105002	M5213L 2SA966Y	
TR101, 102 201, 202 301~303 401, 501	2730204035	2SC2320 E/F	
D101, 201 D301~303	2760002003 2760049008	1N60 1S2076	
RESISTOR GROUP			
R312 R326 R327 R328 R325	2410159002 2410163001 2410179008 2410191002 2410209004	RD14B2H820J RD14B2H121J RD14B2H561J RD14B2H182J RD14B2H104J	Carbon film 82Ω ½W 120Ω ½W 560Ω ½W 1.8KΩ ½W 100KΩ ½W
VR301 VR302 Vr101, 201 Vr402, 502 Vr101, 202 204, 401, 501 Vr103, 203	2118070001 2118067001 2116000031 2116000086 2116000044 2116000057	V1611V35KA503 V1620V30KA103 V08PB102 V08PB204 V08PB503 V08PB304	Variable resistor 50KΩ 10KΩ 1KΩ 200KΩ 50KΩ 300KΩ
CAPACITOR GROUP			
C104, 204 C103, 203 C108, 208 C411, 511 C113, 213 C101, 201 C106, 215 109~111 115, 206 209~211 304~306 C308, 317 C102, 112 114, 202 212, 214 301, 302 409, 509 C307, 309 C310	2533603008 2533620007 2533625002 2533627000 2533635005 2533639001 2544132005 2544134003 2544135002 2544140000 2544141009	CC45SL1H100D CC45SL1H510J CC45SL1H820J CC45SL1H101J CC45SL1H221J CC45SL1H331J CE04W1C100= CE04W1C330= CE04W1C470= CE04W1V4R7= CE04W1V100=	Ceramic 10PF 50V 51PF 50V 82PF 50V 100PF 50V 220PF 50V 330PF 50V Electrolitic 10μF 16V 33μF 16V 47μF 16V 4.7μF 35V 10μF 35V

Ref. No.	Part No.	Part Name	Remarks
C406, 506 C403, 503 C407, 507 C405, 505 C105, 205 C107, 207 408, 508 C402, 404 502, 504 C401, 501 C410, 510	2551060005 2551062003 2551064001 2551065000 2551067008 2551120084 2551069006 2551071007 2551080001	CQ93M1H102K CQ93M1H152K CQ93M1H222K CQ93M1H272K CQ93M1H392K CQ93M1H472K CQ93M1H562K CQ93M1H822K CQ93M1H473K	Film 0.001μF 50V 0.0015μF 50V 0.0022μF 50V 0.0027μF 50V 0.0039μF 50V 0.0047μF 50V 0.0056μF 50V 0.0082μF 50V 0.047μF 50V
OTHER PARTS GROUP			
L402, 502 L301 L401, 501 RL301 S1	2228474005 2328044005 2398014007 2358005001 2140020003 2123330008 2129184009 4358021009 2032075001 2035622008 2035622024	AUDIO AMP P.W.B. BAND TRAP FILTER OSC BLOCK INDUCTOR REED RELAY S.W CONTROL UNIT SLIDE SWITCH FLEX WIRE 2P CONNECTOR BASE 3P MINI CONNE PIN 4P MINI CONNE PIN	
MIC JACK UNIT			
	2049626003 2049627002	HEADPHONE JACK MIC JACK	
PEAK INDICATER UNIT			
	3939094100 3939095109 3939096108 4498058000	LED LED LED LED SUPPORT (C)	
MONITOR DISPLAY UNIT			
	3939148014 3939148027 4498055003	LED LED LED SUPPORT (A)	
MONITOR SWITCH UNIT			
S2	2129181002 2129182001 4358020013	SWITCH CONTROL UNIT SLIDE SWITCH FLEX WIRE	

• The carbon resistors rated at ½W are not listed herein.

KU-0422 AUDIO AMP UNIT (DR-F7/F8) Only

Ref. No.	Part No.	Part Name	Remarks
SEMICONDUCTOR GROUP			
IC311	2620277004	M74LS05P	
IC310	2620346003	HD44750A42	
IC312, 313	2620276005	HD14066BP	
IC301	2630189001	M5218L	
IC308	2630161003	μ PC358C	
IC303	2630092004	LB1416	
IC302, 309 304~307	2630189001	M5218L	
IC101, 201	2650029002	M5213L	
TR355	2710105002	2SA966Y	
TR303, 312	2710102034	2SA1015 Y/GR	
TR101~105 201~205 301~305 307, 354 309~311 313, 314 351, 352 356, 357 401~404 501~504	2730204035	2SC2320 E/F	
TR306, 308	2730195005	2SC2060 (Q)	
D101, 201	2760002003	1N60	
D104, 105 204, 205	2760001004	1N34A	
D102, 103 202, 203 302~313 501	2760049008	1S2076	
D301	2760237001	RV06	
RESISTOR GROUP			
R311	2410159002	RD14B2H820J	Carbon film 82 Ω $\frac{1}{2}$ W
R31	2410165009	RD14B2H151J	150 Ω $\frac{1}{2}$ W
R182, 188 282, 288	2412168004	RD14B2H155J	1.5M Ω $\frac{1}{2}$ W
VR301	2118070001	V1611V35KA503	Variable resistor 50K Ω
VR302	2118067001	V1620V30KA103	10K Ω
Vr101, 201	2116000031	V08PB102	1K Ω
Vr302	2116000002	V08PB502	5K Ω
Vr104, 204	2116000073	V08PB203	20K Ω
Vr102, 105 202, 205	2116000044	V08PB503	50K Ω
Vr301	2116000028	V08PB104	100K Ω
Vr106, 206	2116000086	V08PB204	200K Ω
Vr103, 203	2116000057	V08PB304	300K Ω
CAPACITOR GROUP			
C105, 205	2533603008	CC45SL1H100D	Ceramic 10PF 50V
C104, 204	2533620007	CC45SL1H510J	51PF 50V
C110, 210	2533625002	CC45SL1H820J	82PF 50V
C101, 201	2533639001	CC45SL1H331J	330PF 50V
C119, 219	2531055069	CK45B1H101K	100PF 50V

Ref. No.	Part No.	Part Name	Remarks
C151, 251	2531055056	CK45B1H221K	Ceramic 220PF 50V
CB301, 302	2531151002	CK99B1H102MP4	1000PF 50V
C102, 114 117, 152 202, 214 217, 252 354	2544129005	CE04W1A470=	Electrolytic 47 μ F 10V
C107, 120 111~113 153, 156 207, 220 211~213 253, 256 301~303	2544132005	CE04W1C100=	10 μ F 16V
C305, 351	2544134003	CE04W1C330=	33 μ F 16V
C121, 221 306, 308 309	2544135002	CE04W1C470=	47 μ F 16V
C122, 222 304, 310 352	2544140000	CE04W1V4R7=	4.7 μ F 35V
C307	2549014018	CE04W1HR22H	0.22 μ F 50V Film
C254, 255	2551061004	CQ93M1H122K	0.0012 μ F 50V
C402, 502	2551062003	CQ93M1H152K	0.0015 μ F 50V
C405, 505	2551064001	CQ93M1H222K	0.0022 μ F 50V
C404, 504	2551065000	CQ93M1H272K	0.0027 μ F 50V
C108, 208	2551067008	CQ93M1H392K	0.0039 μ F 50V
C109, 116 209, 216	2551068007	CQ93M1H472K	0.0047 μ F 50V
C401~403 503	2551069006	CQ93M1H562K	0.0056 μ F 50V
C115, 215 406, 506	2551071007	CQ93M1H822K	0.0082 μ F 50V
C154, 155	2551074004	CQ93M1H153K	0.015 μ F 50V
C353	2551076002	CQ93M1H223K	0.022 μ F 50V
C118, 218	2551080001	CQ93M1H473K	0.047 μ F 50V
OTHER PARTS GROUP			
L102, 202	2228453000	AUDIO AMP P.W.B	
L301	2328044005	BAND TRAP FILTER	
L101, 201 302	2398012009	OSC BLOCK	
	2358005001	INDUCTOR	
	2358008008	INDUCTOR	
S301	2129178002	SELECTOR SWITCH	
RL301	2140020003	REED RELAY	

● The carbon resistors rated at $\frac{1}{2}$ W are not listed herein.

Ref. No.	Part No.	Part Name	Remarks
KU-0422A MIC JACK UNIT			
	2049626003	HEADPHONE JACK	
	2049627002	MIC JACK	
KU-0422B TUNING DISPLAY UNIT			
	2129130008	PUSH SWITCH	
	3939095109	LED	
	4498056002	LED SUPPORT (B)	
KU-0422C PEAK INDICATOR UNIT			
	3939094100	LED	RED
	3939095109	LED	GRN
	3939096108	LED	YEL
	4498058107	LED SUPPORT (C)	
KU-0422D MONITOR DISPLAY UNIT			
	3939148014	LED	GRN
	3939148027	LED	YEL
	4498055003	LED SUPPORT (A)	
KU-0422E MONITOR SWITCH UNIT			
	2129145006	PUSH SWITCH	

KU-0439 LEADER DETECTOR UNIT

Ref. No.	Part No.	Part Name	Remarks
SEMICONDUCTOR GROUP			
TR52	2710102034	2SA1015 Y/GR	
TR51	2730204035	2SC2320 E/F	
D51, 52	2760049008	IS2076	
RESISTOR GROUP			
R52, 56	2412096008	RD14B2E152J	Carbon film 1.5K Ω 1/4W
R57	2412100004	RD14B2E222J	2.2K Ω 1/4W
R51, 53	2412108006	RD14B2E472J	4.7K Ω 1/4W
R54, 55	2412126004	RD14B2E273J	27K Ω 1/4W
Vr51	2116000044	V08PB503	Variable resistor 50K Ω
CAPACITOR GROUP			
C51	2544054002	CE04W1C220=	Electrolytic 22 μ F 16V
OTHER PARTS GROUP			
	2228486006	LEADER DET. P.W.B.	

KU-0434 QUARTS LOCKED UNIT

Ref. No.	Part No.	Part Name	Remarks
SEMICONDUCTOR GROUP			
IC901	2630203000	MSL9348RS	
TR901	2730204035	2SC2320 E/F	
DZ901	2760173000	HZ6A	
LE901	3939148001	LED	
CAPACITOR GROUP			
C901, 902	2533627000	CC45SL1H101J	Ceramic 100pF 50V
C903	2544003008	CE04W0J101=	Electrolytic 100pF 6.3V
C904	2544043000	CE04W1HR47	0.47 μ F 50V
OTHER PARTS GROUP			
	2228470009	QUARTZ P.W.B.	
	3998024001	CRYSTAL 3.711MHZ	
	2039617006	4P, EI CON. WIRE	

KU-0426/0426-1 P.L.S. D.D. UNIT

Ref. No.	Part No.	Part Name	Remarks
SEMICONDUCTOR GROUP			
IC1	2630161003	μ PC358C	
IC2	2630122000	CX065A	
IC3	2630189001	M5218L	
TR4, 6	2720055029	2SB772 Q/P	
TR1, 2	2730204035	2SC2320 E/F	
TR3, 5	2740078031	2SD882 Q/P	
D1~3	2760049008	1S2076	
RESISTOR GROUP			
R9	2452231001	RN14K2E104G	Metal film 100K Ω 1/4W
Vr1	2116020011	K08Q06MB503	Variable resistor 50K Ω
CAPACITOR GROUP			
C1	2539015001	CK45=1E104M	Ceramic 0.1 μ F 25V
C11	2539029000	CK45=1E154M	0.15 μ F 25V
C2	2531025002	CK45F1H223Z	0.022 μ F 50V
C12	2539023909	CK45=1E153MT	0.015 μ F 25V
C9, 10	2544134003	CE04W1C330=	Electrolytic 33 μ F 16V
C13	2544140000	CE04W1V4R7=	4.7 μ F 35V
C3, 4	2544146004	CE04W1H010=	1 μ F 50V
C6	2551060005	CQ93M1H102K	Film 0.001 μ F 50V
C5	2551064001	CQ93M1H222K	0.0022 μ F 50V
C14, 15	2551076002	CQ93M1H223K	0.022 μ F 50V
C8	2551083008	CQ93M1H823K	0.082 μ F 50V
C16	2556119003	CQ09S1H682J	0.0068 μ F 50V
C7	2556123002	CQ09S1H103J	0.01 μ F 50V
OTHER PARTS GROUP			
CN1	2228451109	D.D. MOTOR P.W.B.	
	2032075001	2P CONNECTOR BASE	
	2039617006	4P EI CONNE. WIRE	
	2045396007	10P EI CONNE. WIRE	
TR7	2730204035	2SC2320 E/F	(KU-0426-1) only
CN2	2035622024	4P MINI CONNE. PIN	(KU-0426-1) only

• The carbon resistors rated at 1/4W are not listed herein.

KU-0421 LOGIC AND POWER UNIT

Ref. No.	Part No.	Part Name	Remarks
SEMICONDUCTOR GROUP			
IC801	2620350002	MSL9316RS	
IC802	2620197003	M74LS32P	
IC803	2620192008	M74LS09P	
IC804	2620277004	M74LS05P	
IC805	2630139006	μ PC78M12H	
IC806	2630168006	μ PC7912H	
TR801~804 808, 810, 813, 815, 819, 822	2710102034	2SA1015 Y/GR	
TR809, 814	2710117003	2SA1020Y	
TR821, 824	2720055029	2SB772 Q/P	
TR806, 807 812, 817, 818, 823	2730204035	2SC2320 E/F	
TR811, 816	2740080029	2SD794 Q/P	
TR805, 820	2740078031	2SD882 Q/P	
DB801~803 D808	2760246005	RB-152	
810~812 814, 815	2760237001	RV06	
D801~807 809, 813 816~820	2760049008	IS2076	
DZ801	2760173042	HZ6B1	
DZ804	2760299010	HZ3A3	
DZ802, 803	2760173068	HZ6B3	
RESISTOR GROUP			
R836	2440027023	RS14B3A680JNBF	Metal film 68 Ω 1W
R863, 864	2440082026	RS14B3D470JNBF	47 Ω 2W
R841, 842	2440084024	RS14B3D680JNBF	68 Ω 2W
CAPACITOR GROUP			
C802, 819 827	2539022900	CK45=1E103MT	Ceramic 0.01 μ F 25V
C805, 823	2539024908	CK45=1E223MT	0.022 μ F 25V
C824	2539015001	CK45=1E104M	0.1 μ F 25V
CB801	2610036006	CK93F1H103ZF6	0.01 μ F 50V Electrolitic
C801, 806 811, 812	2544129005	CE04W1A470=	47 μ F 10V
C807, 808	2544132005	CE04W1C100=	10 μ F 16V
C817, 818	2544136001	CE04W1C101=	100 μ F 16V
C813, 814	2544022005	CE04W1C102	1000 μ F 16V
C826, 828	2544135002	CE04W1E470=	47 μ F 25V
C825	2544029008	CE04W1E221=	220 μ F 25V
C809, 810 815, 816	2544032008	CE04W1E102=	1000 μ F 25V
C820~822	2544140000	CE04W1V4R7=	4.7 μ F 35V
C803	2544145005	CE04W1HR47=	0.47 μ F 50V

Ref. No.	Part No.	Part Name	Remarks
OTHER PARTS GROUP			
	2228452001	LOGIC POWER P.W.B	
	4178076108	HEAT SINK (U)	
	4178062109	HEAT SINK (L)	
	2035622008	3P MINI CONNE PIN	
	2035622024	4P MINI CONNE PIN	
	2035622037	8P MINI CONNE PIN	
	2035622040	10 P MINI CONNE PIN	
	2035688000	3P EI CONNE WIRE	
	2045351026	8P EI CONNE WIRE	
KU-0421A CONTROL BOTTON UNIT			
S801~806	2129130008	PUSH SWITCH	
LE803	3939148001	LED	RED
LE802	3939148014	LED	GRN
LE801	3939148027	LED	YEL
	4498055003	LED SUPPORT (A)	
KU-0421B TIMER UNIT			
S807	2129179001	SLIDE SWITCH	
KU-0421C REMOCON UNIT			
CJ801	2049624319	8P JACK	
KU-0421D HALL IC UNIT			
IC807	2680028002	DN-6838	
	4498059106	HALL IC GUIDE	

KU-0446 PWER WIRING UNIT

Ref. No.	Part No.	Part Name	Remarks
	2410163001	RD14B2H121J	120 Ω , 1/2W
	2518001007	CP05C = AC103M	0.01 μ /4500~
	2228498007	AC POWER BOARD	
	FEP1287	FUSE HOLDER	
	2061015045	FUSE	0.315mA
	EE-1656	BASE TERMINAL	

KU-0447 POWER WIRING UNIT

Ref. No.	Part No.	Part Name	Remarks
	2410163001	RD14B2H121J	120 Ω , 1/2W
	2518001007	CP05C = AC103M	0.01 μ /4500~
	2228506009	AC POWER BOARD	
	FEP1287	FUSE HOLDER	
	2061015003	FUSE (500mA)	
	EE-1656	BASE TERMINAL	

EXPLODED VIEW OF MECHANISM UNIT

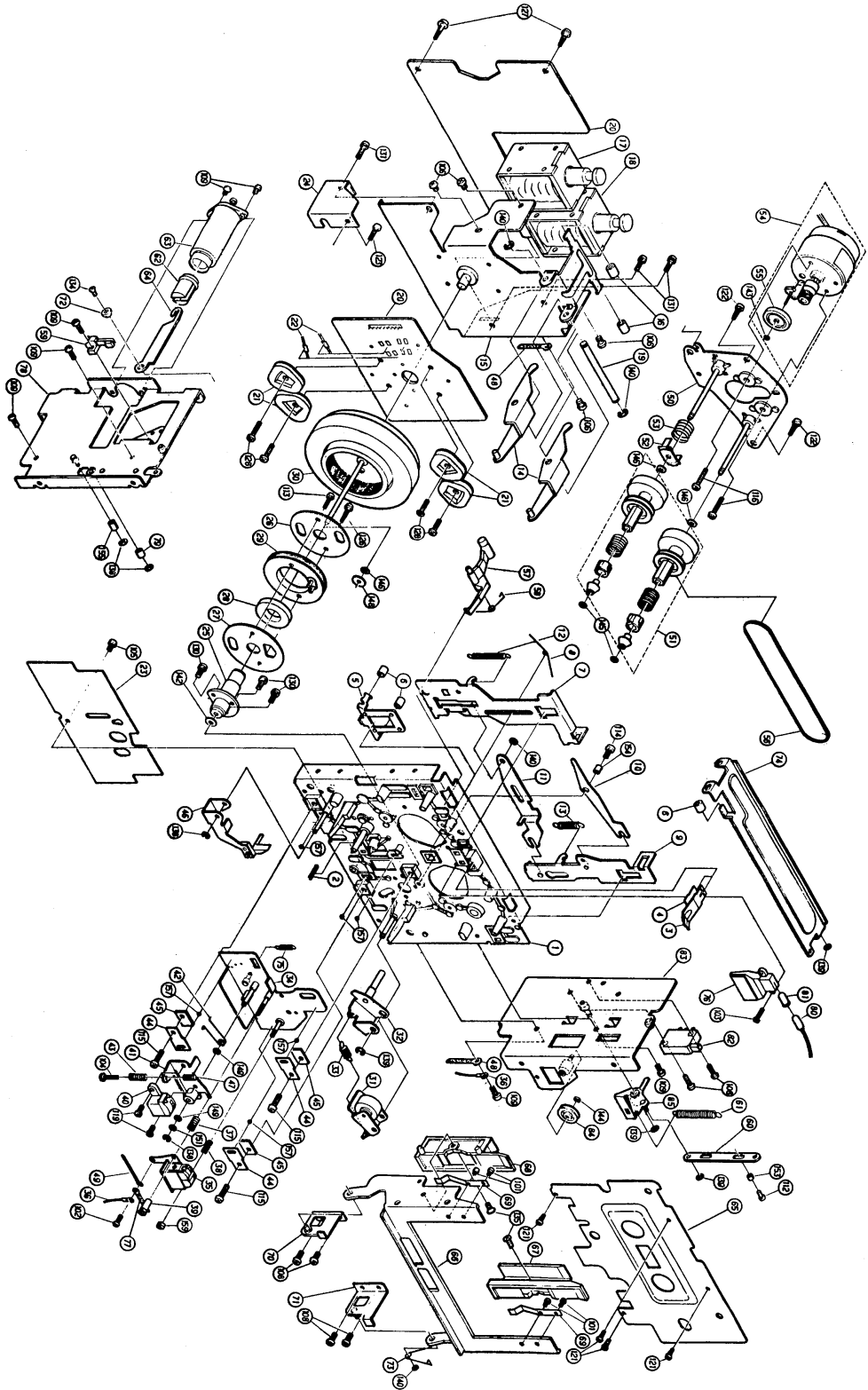

EXPLODED VIEW OF CABINET AND CHASSIS GROUP (MODEL DR-F6)

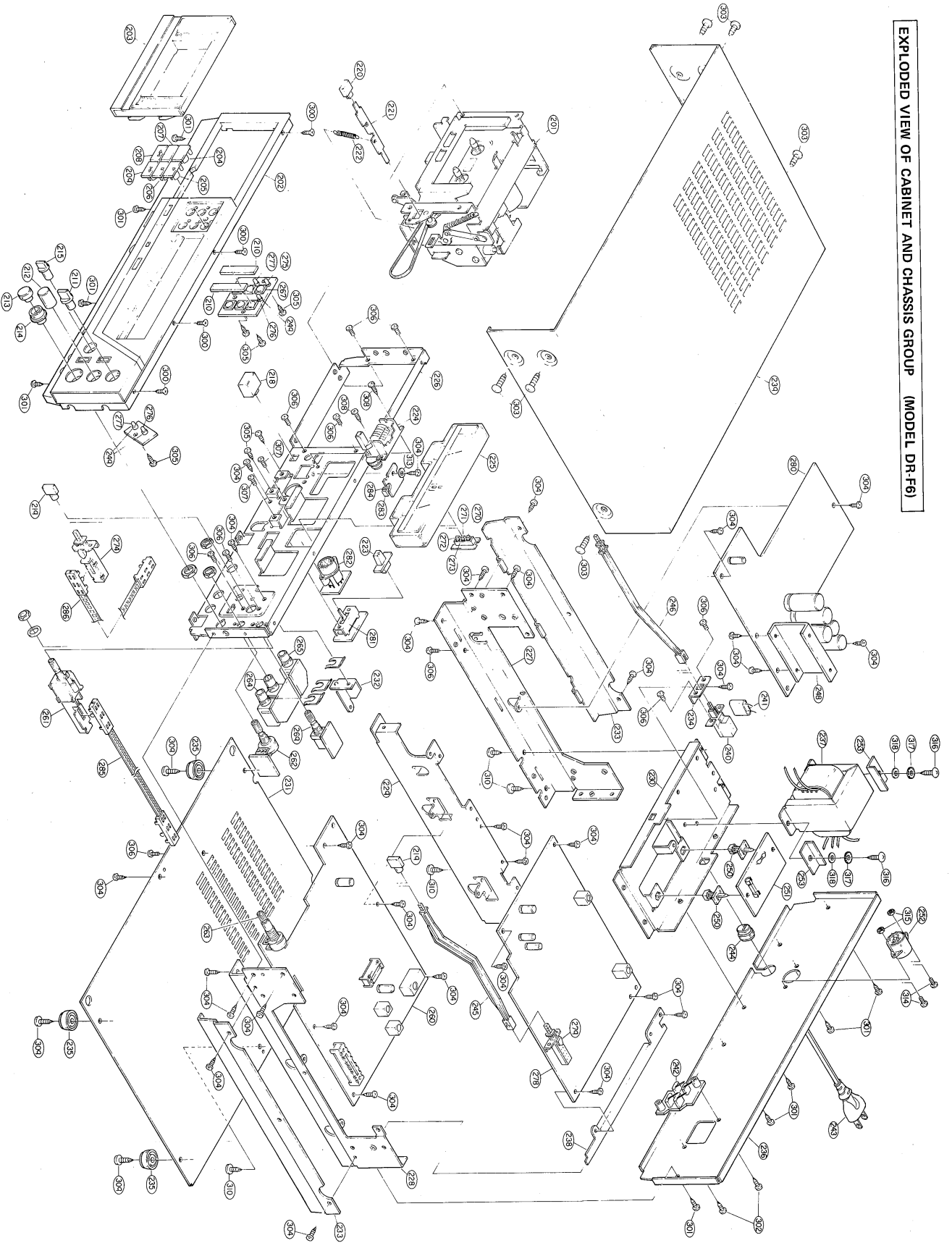

CONNECTIONS OF P.C. BOARD (MODEL DR-F6)

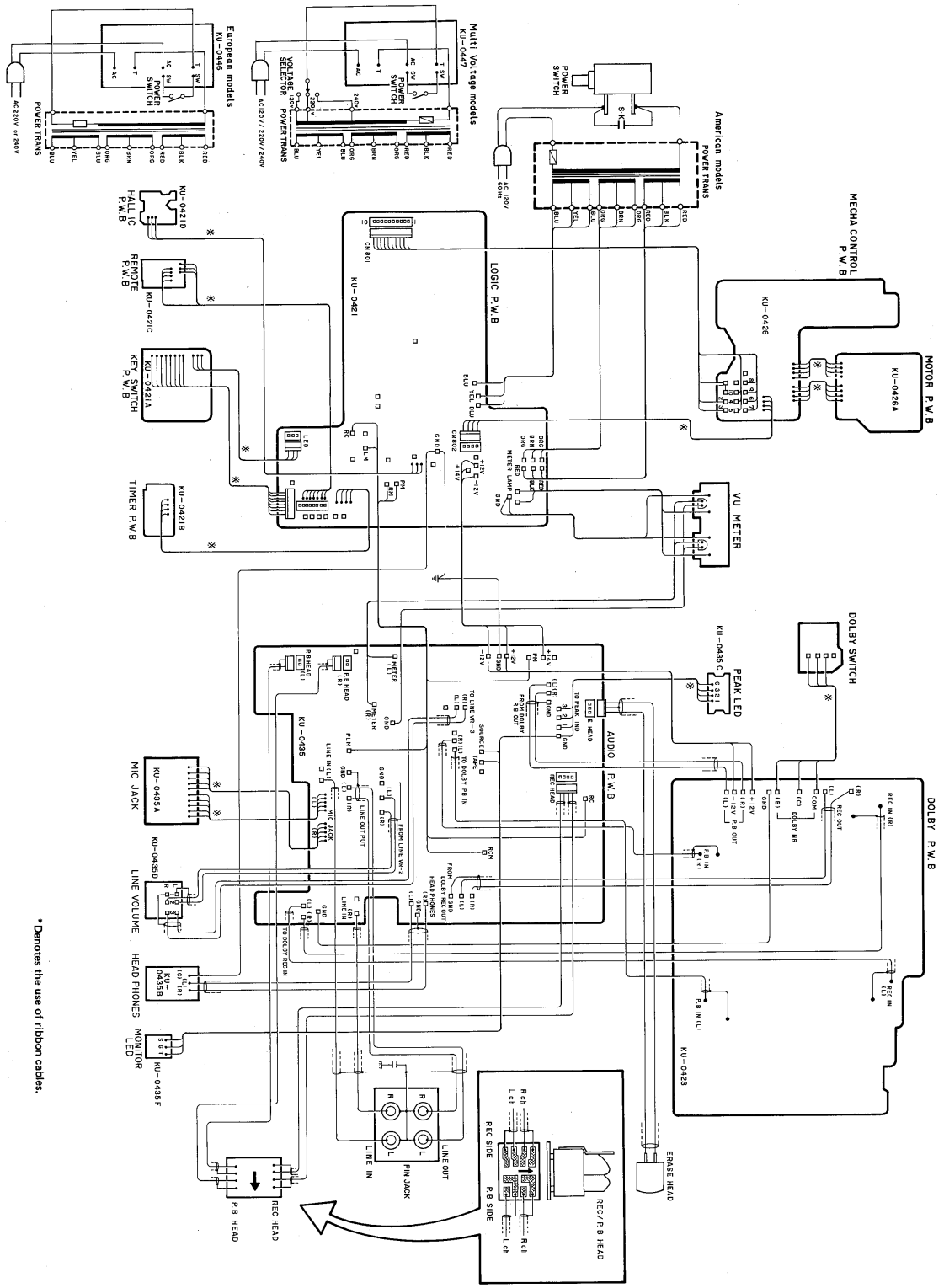

* Denotes the use of ribbon cables.

CONNECTIONS OF P.C. BOARD (MODEL DR-F7/F8)

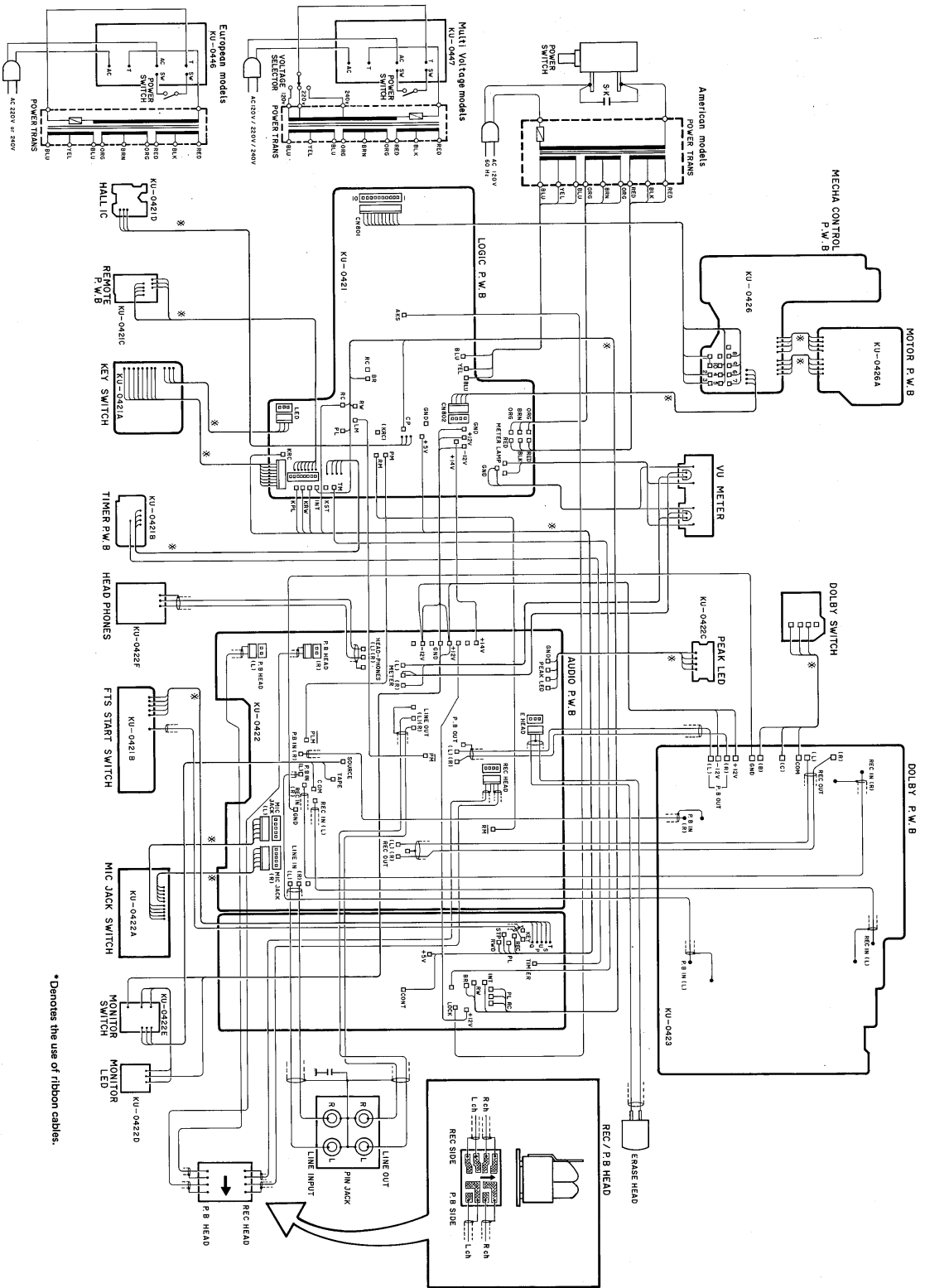

SCHEMATIC DIAGRAM OF LOGIC AND POWER UNIT (MODEL DR-F6/F7)

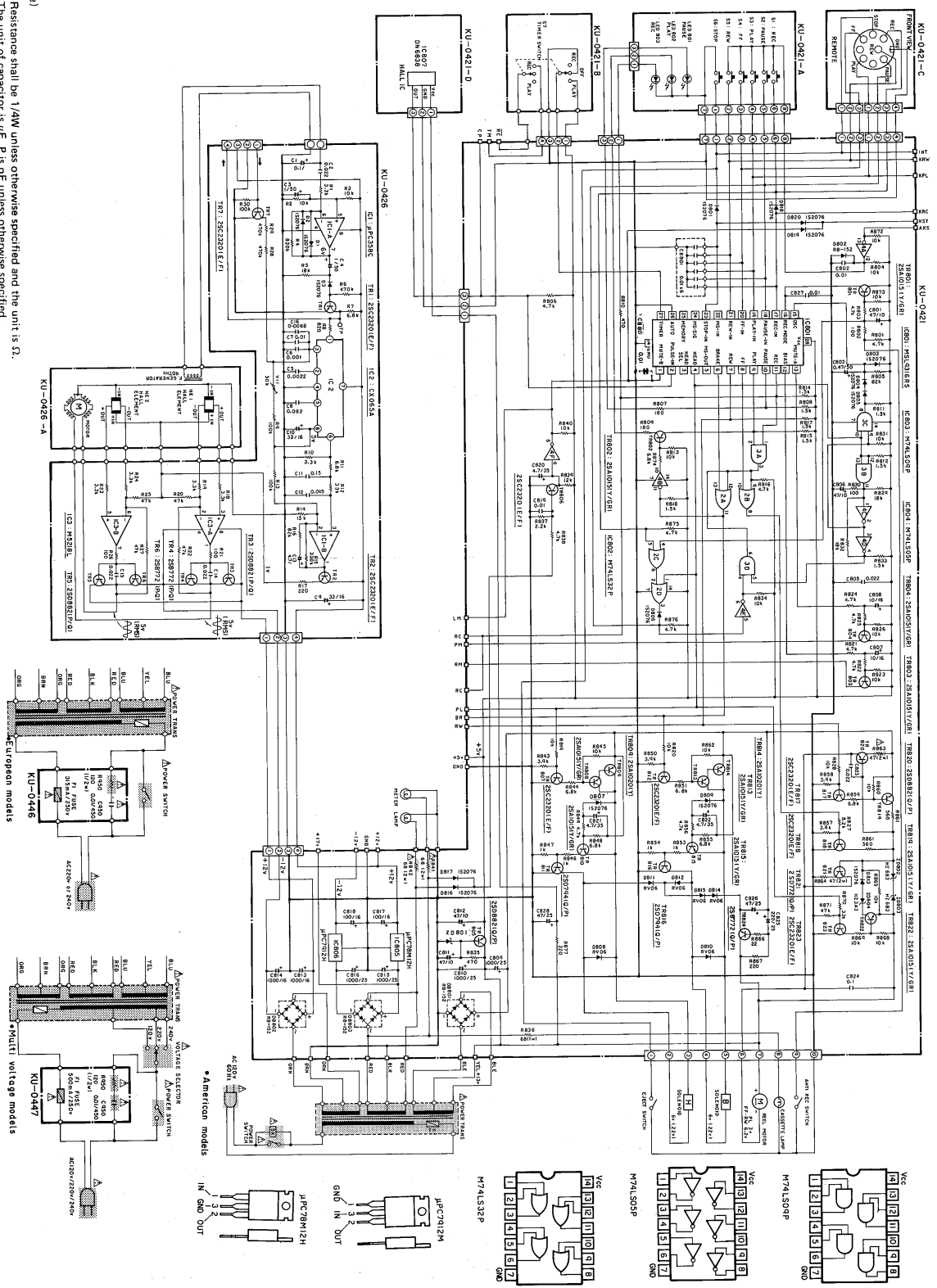

- (N106)
- Resistance shall be 1/4W unless otherwise specified and the unit is Ω.
 - The unit of capacitor is μF, P is pF unless otherwise specified.
 - Parts marked with Δ are of importance in respect to the safety, use the specified type without fail.
 - The voltage values are measured using the circuit tester (DC 100kΩ/V).
 - This circuit diagram shows the basic circuit it is subject to change for the purpose of improvement.

SCHEMATIC DIAGRAM OF AUDIO AMP (MODEL DR-F8)

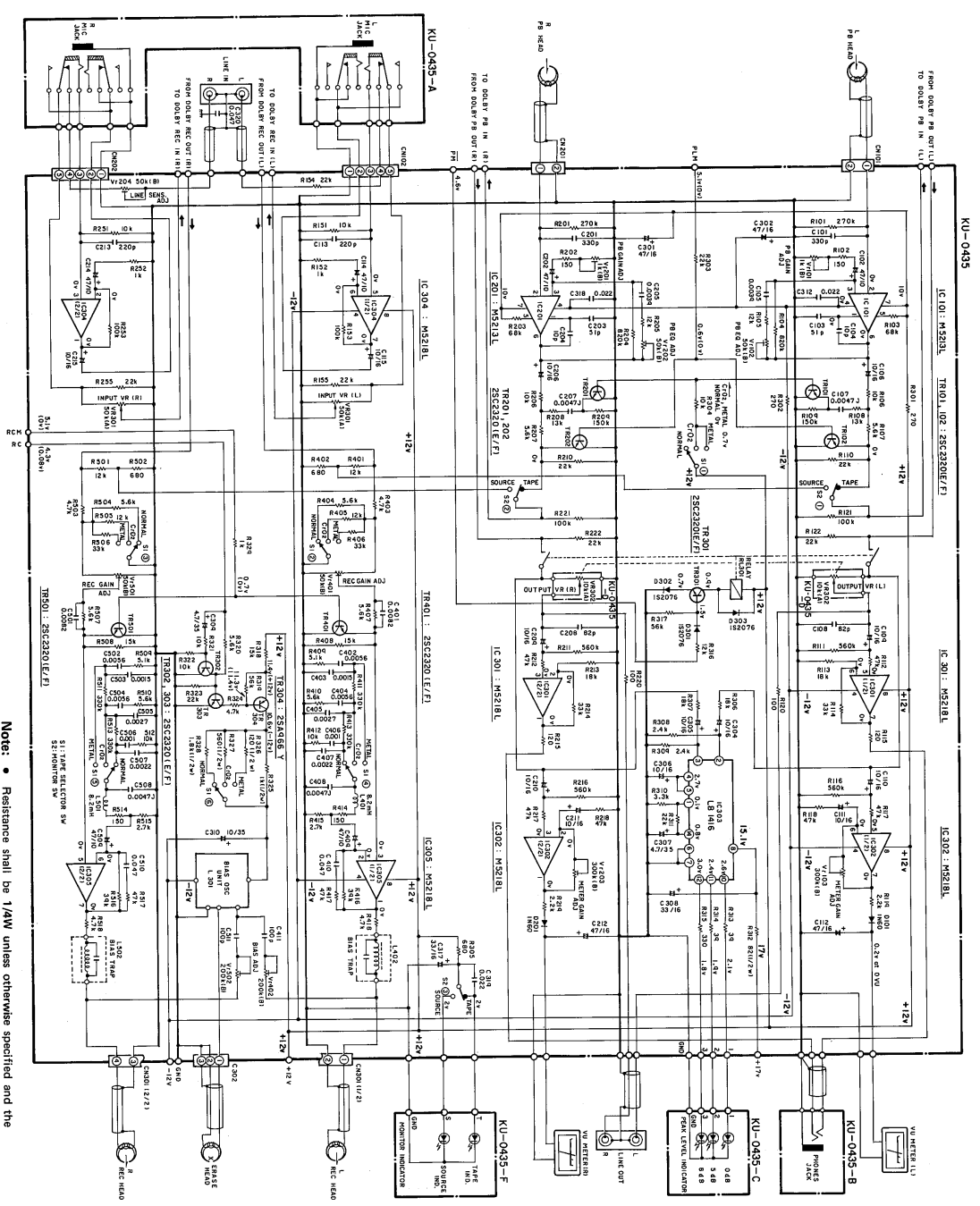

Notes:

- Resistance shall be 1/4W unless otherwise specified and the unit is Ω.
- The unit of capacitor is μF, P is pF unless otherwise specified.
- This circuit diagram shows the basic circuit. It is subject to change for the purpose of improvement.

SCHEMATIC DIAGRAM OF DOLBY AMP.

KJ-0423

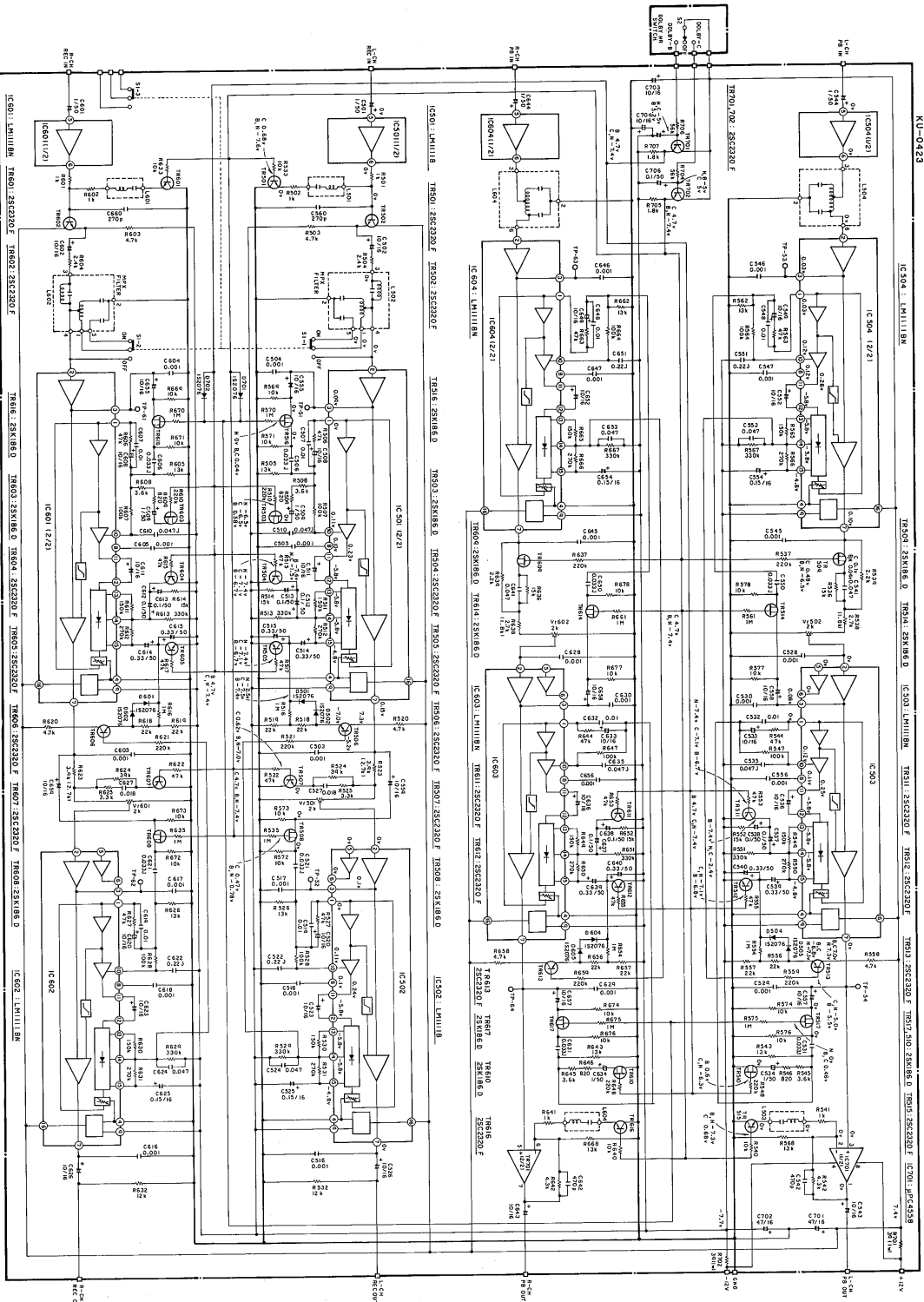

Note:

- Resistance shall be 1/4W unless otherwise specified and the unit is Ω .
- The unit of capacitor is μF , P is pF unless otherwise specified.
- This circuit diagram shows the basic circuit. It is subject to change for the purpose of improvement.

P.C. BOARD OF KU-0435 AUDIO AMP. UNIT (MODEL DR-F6)

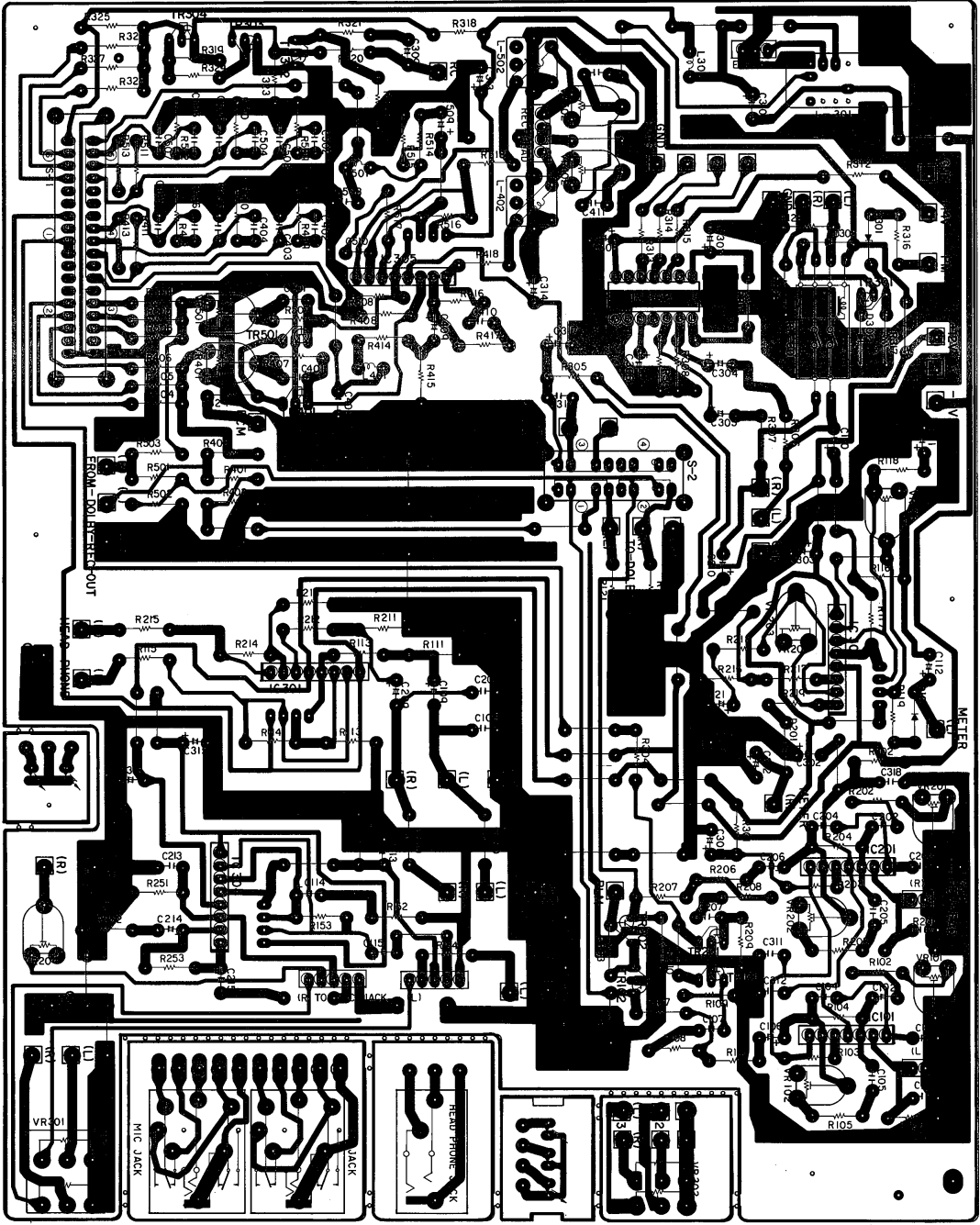

(10)

(10)

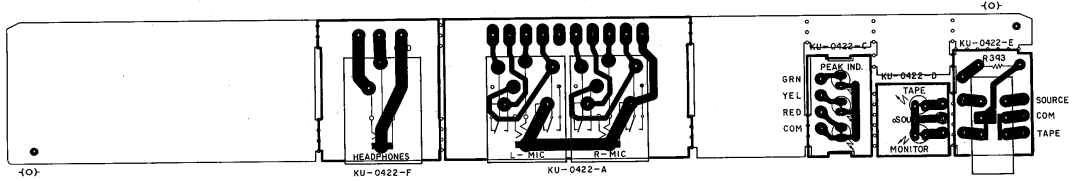
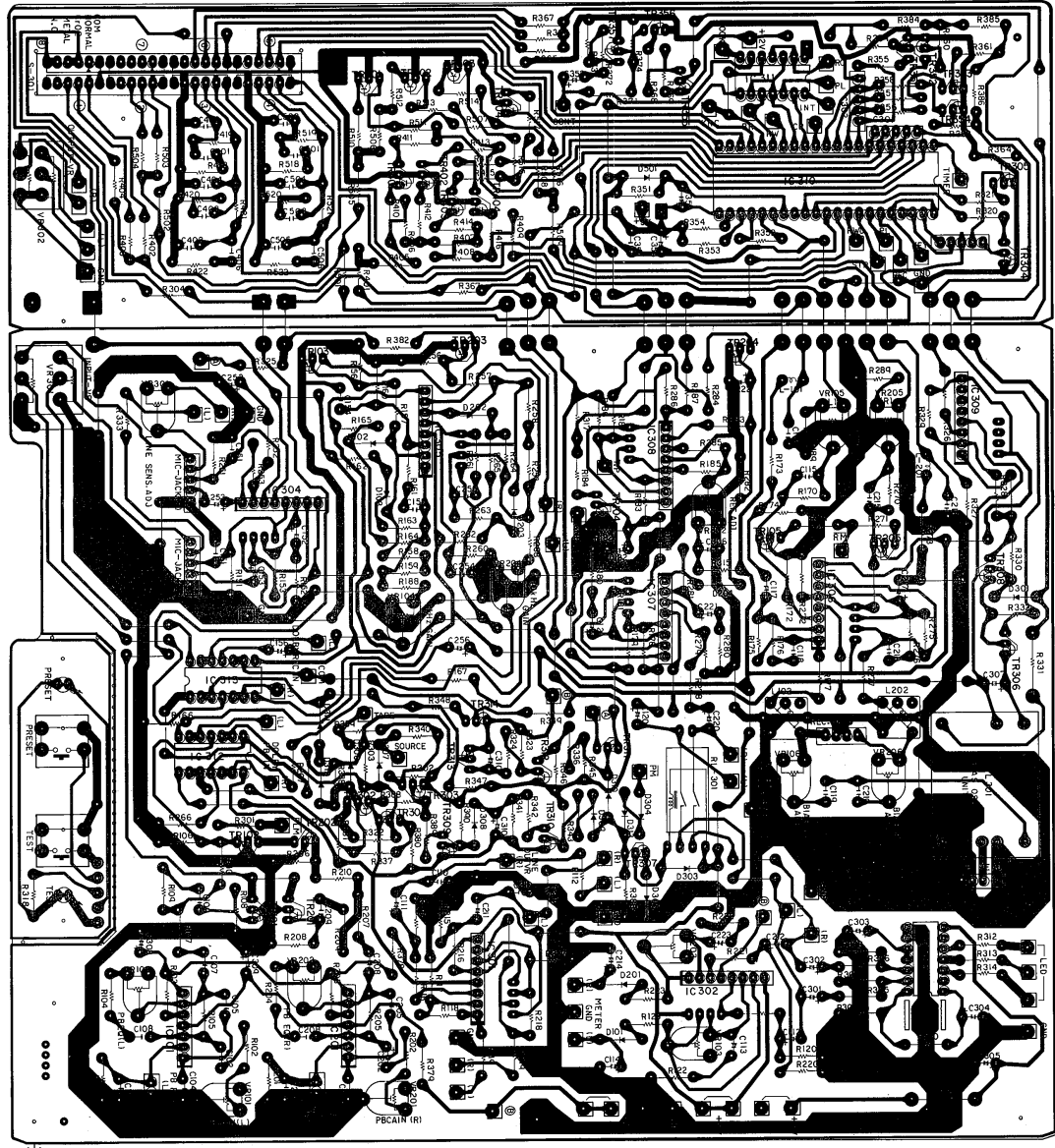

(10)

KU-0422-F

KU-0422-A

(10)

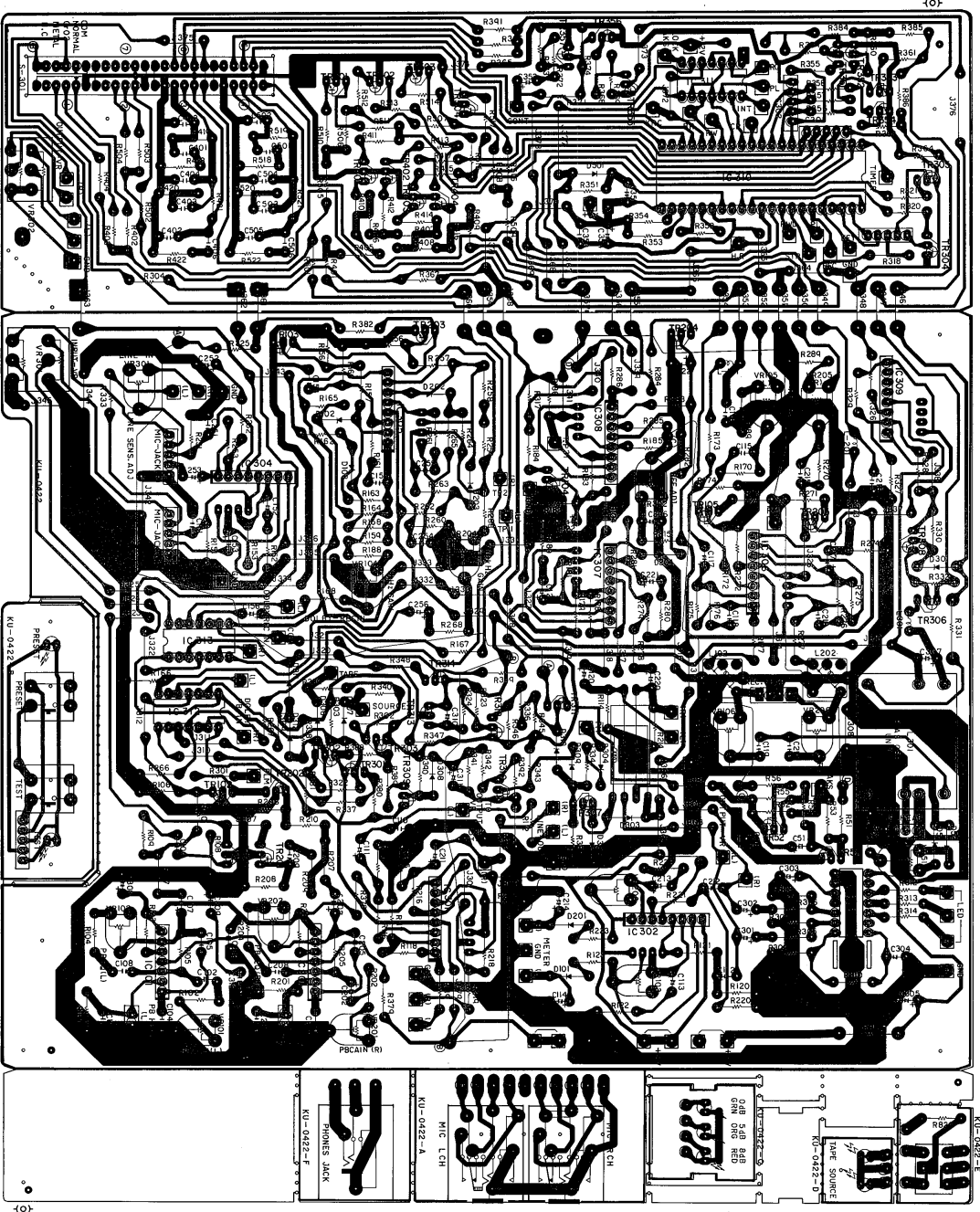

P.C. BOARD OF KU-0423 DOLBY AMP. UNIT REVISED

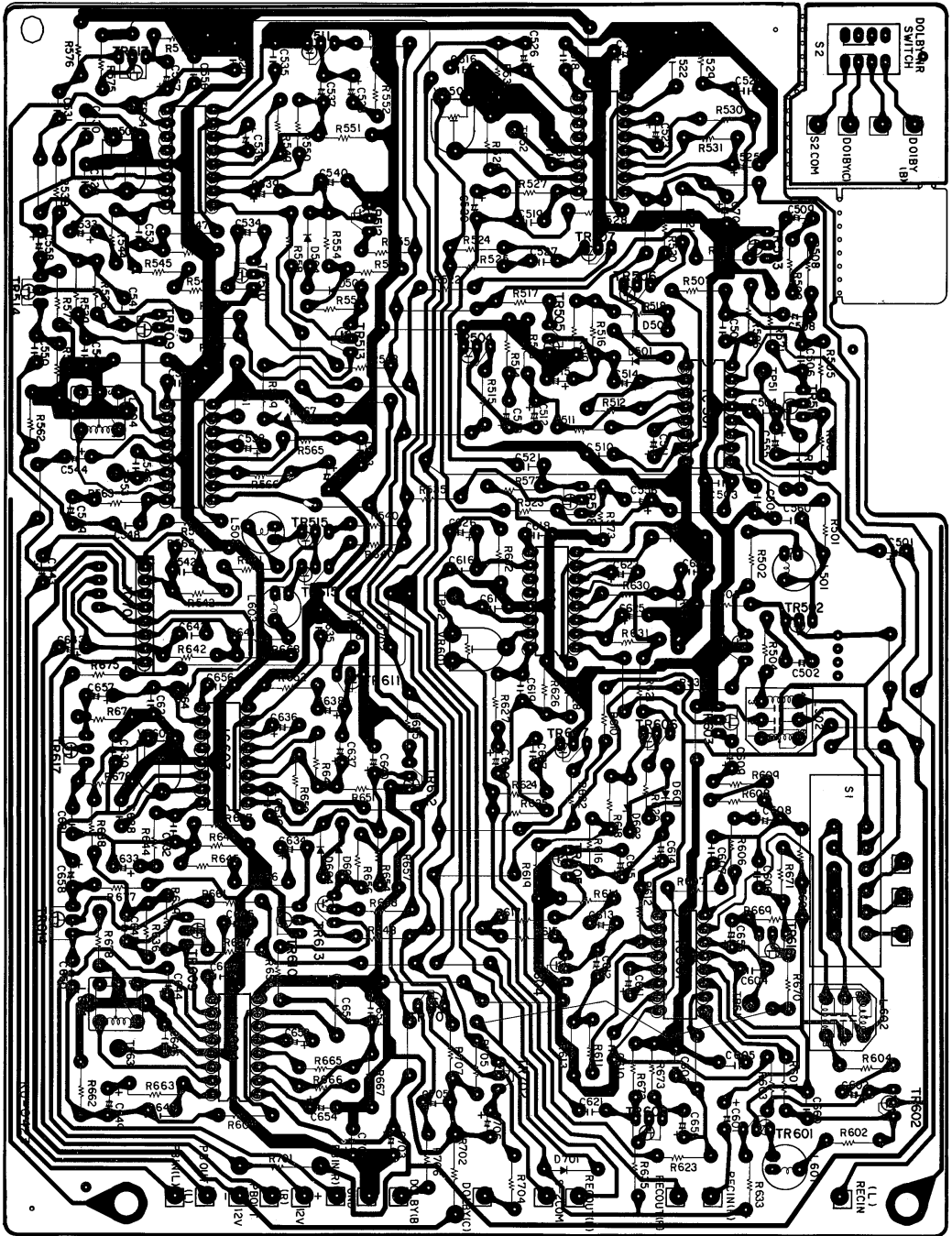

10

10

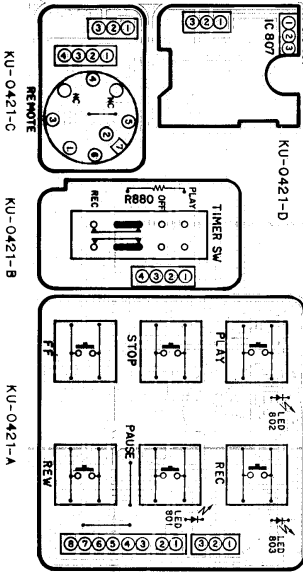
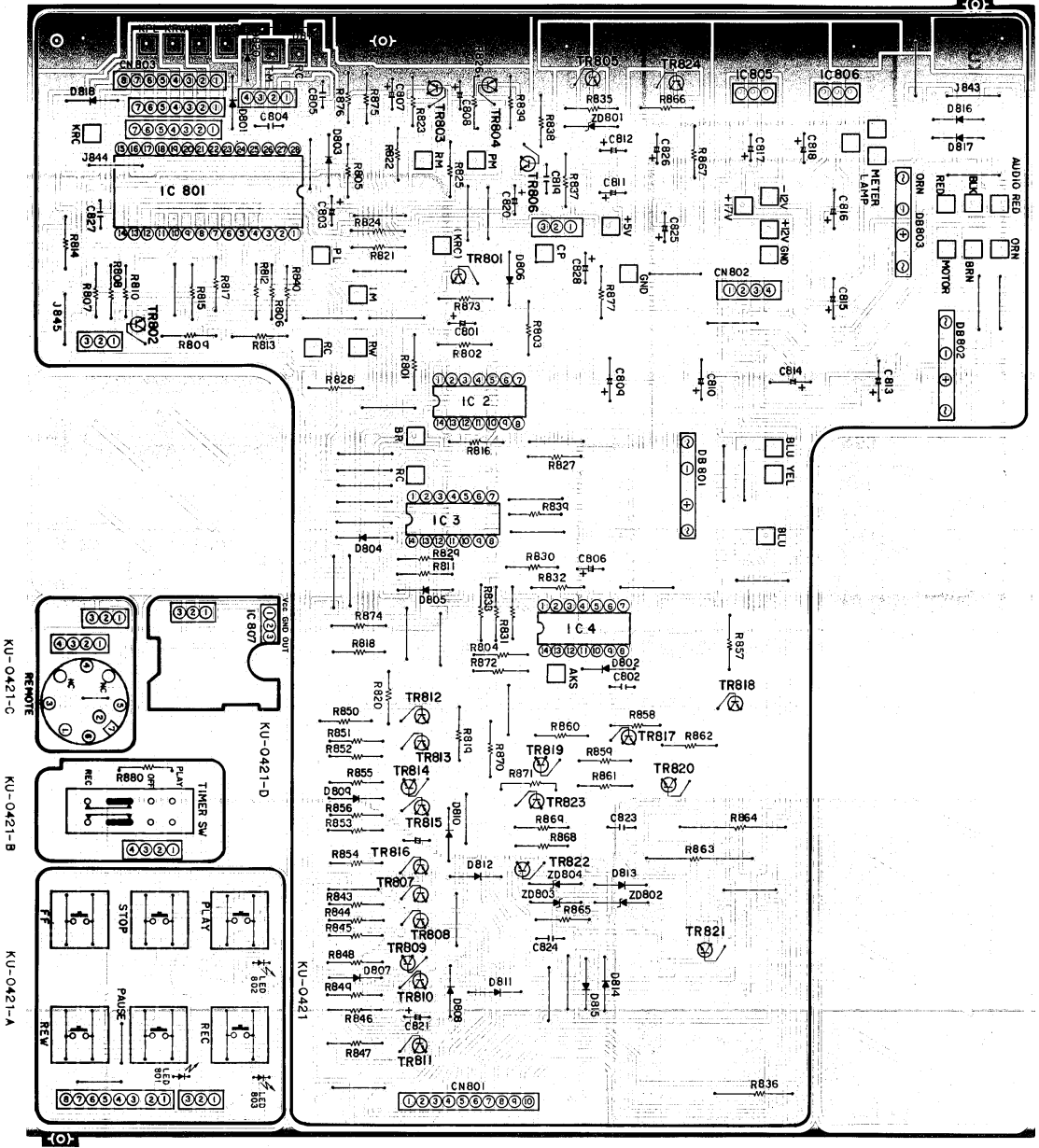

ON

NIPPON COLUMBIA CO., LTD.

No. 14-14, 4-CHOME AKASAKA,
MINATO-KU, TOKYO JAPAN
TEL: 03-584-8111
TLX: JAPANOLA J22591
CABLE: NIPPON COLUMBIA TOKYO